



Octal, 12-Bit, 40Msps, 1.8V ADC with Serial LVDS Outputs

MAX1436

General Description

The MAX1436 octal, 12-bit analog-to-digital converter (ADC) features fully differential inputs, a pipelined architecture, and digital error correction incorporating a fully differential signal path. This ADC is optimized for low-power and high-dynamic performance in medical imaging instrumentation and digital communications applications. The MAX1436 operates from a 1.8V single supply and consumes only 743mW (93mW per channel) while delivering a 69.9dB (typ) signal-to-noise ratio (SNR) at a 5.3MHz input frequency. In addition to low operating power, the MAX1436 features a power-down mode for idle periods.

An internal 1.24V precision bandgap reference sets the full-scale range of the ADC. A flexible reference structure allows the use of an external reference for applications requiring increased accuracy or a different input voltage range. The reference architecture is optimized for low noise.

A single-ended clock controls the data-conversion process. An internal duty-cycle equalizer compensates for wide variations in clock duty cycle. An on-chip PLL generates the high-speed serial low-voltage differential signal (LVDS) clock.

The MAX1436 has self-aligned serial LVDS outputs for data, clock, and frame-alignment signals. The output data is presented in two's complement or binary format.

The MAX1436 offers a maximum sample rate of 40Msps. See the *Pin-Compatible Versions* table below for higher-speed versions. This device is available in a small, 14mm x 14mm x 1mm, 100-pin TQFP package with exposed paddle and is specified for the extended industrial (-40°C to +85°C) temperature range.

Applications

Ultrasound and Medical Imaging
Instrumentation
Multichannel Communications

Features

- ◆ Excellent Dynamic Performance
 - 69.9dB SNR at 5.3MHz
 - 96dBc SFDR at 5.3MHz
 - 95dB Channel Isolation
- ◆ Ultra-Low Power
 - 93mW per Channel (Normal Operation)
- ◆ Serial LVDS Outputs
- ◆ Pin-Selectable LVDS/SLVS (Scalable Low-Voltage Signal) Mode
- ◆ LVDS Outputs Support Up to 30 Inches FR-4 Backplane Connections
- ◆ Test Mode for Digital Signal Integrity
- ◆ Fully Differential Analog Inputs
- ◆ Wide Differential Input Voltage Range (1.4V_{p-p})
- ◆ On-Chip 1.24V Precision Bandgap Reference
- ◆ Clock Duty-Cycle Equalizer
- ◆ Compact, 100-Pin TQFP Package with Exposed Paddle
- ◆ Evaluation Kit Available (Order MAX1436EVKIT)

Ordering Information

| PART | TEMP RANGE | PIN-PACKAGE |
|------------|----------------|-------------------------------------|
| MAX1436ECQ | -40°C to +85°C | 100 TQFP-EP* (14mm x 14mm x 1mm) |

*EP = Exposed paddle.

Pin-Compatible Versions

| PART | SAMPLING RATE (Msps) | RESOLUTION (BITS) |
|-----------|----------------------|-------------------|
| MAX1434 | 50 | 10 |
| MAX1437 | 50 | 12 |
| MAX1438** | 65 | 12 |

**Future product—contact factory for availability.

Pin Configuration appears at the end of data sheet.



Maxim Integrated Products 1

For pricing, delivery, and ordering information, please contact Maxim/Dallas Direct! at 1-888-629-4642, or visit Maxim's website at www.maxim-ic.com.

Octal, 12-Bit, 40MSPS, 1.8V ADC with Serial LVDS Outputs

ABSOLUTE MAXIMUM RATINGS

| | |
|------------------------------------------------------------------------------------------|------------------------------------|
| AV _{DD} to GND | -0.3V to +2.0V |
| CV _{DD} to GND | -0.3V to +3.6V |
| OV _{DD} to GND | -0.3V to +2.0V |
| IN _P , IN _N to GND | -0.3V to (AV _{DD} + 0.3V) |
| CLK to GND | -0.3V to (CV _{DD} + 0.3V) |
| OUT _P , OUT _N , FRAME ₊ , CLKOUT ₊ to GND | -0.3V to (OV _{DD} + 0.3V) |
| DT, SLVS/LVDS, LVDSTEST, PLL ₊ , T/B, REFIO, REFADJ, CMOUT to GND | -0.3V to (AV _{DD} + 0.3V) |

| | |
|----------------------------------------------------------------------------------------------------------------------------|-----------------|
| Continuous Power Dissipation (T _A = +70°C) 100-Pin TQFP 14mm x 14mm x 1mm (derated 47.6mW/°C above +70°C) | 3809.5mW |
| Operating Temperature Range | -40°C to +85°C |
| Maximum Junction Temperature | +150°C |
| Storage Temperature Range | -65°C to +150°C |
| Lead Temperature (soldering, 10s) | +300°C |

Stresses beyond those listed under "Absolute Maximum Ratings" may cause permanent damage to the device. These are stress ratings only, and functional operation of the device at these or any other conditions beyond those indicated in the operational sections of the specifications is not implied. Exposure to absolute maximum rating conditions for extended periods may affect device reliability.

ELECTRICAL CHARACTERISTICS

(AV_{DD} = 1.8V, OV_{DD} = 1.8V, CV_{DD} = 3.3V, GND = 0, external V_{REFIO} = 1.24V, C_{REFIO} to GND = 0.1μF, C_{REFP} to GND = 10μF, C_{REFN} to GND = 10μF, f_{CLK} = 40MHz (50% duty cycle), V_{DT} = 0, T_A = T_{MIN} to T_{MAX}, unless otherwise noted. Typical values are at T_A = +25°C.) (Note 1)

| PARAMETER | SYMBOL | CONDITIONS | MIN | TYP | MAX | UNITS |
|-------------------------------------------------------------------------------|--------------------|---------------------------------------|------|-------|------|------------------|
| DC ACCURACY (Note 2) | | | | | | |
| Resolution | N | | 12 | | | Bits |
| Integral Nonlinearity | INL | | | ±0.4 | ±3 | LSB |
| Differential Nonlinearity | DNL | No missing codes over temperature | | ±0.25 | ±1 | LSB |
| Offset Error | | | | | ±0.5 | %FS |
| Gain Error | | | | | ±2.4 | %FS |
| ANALOG INPUTS (IN_P, IN_N) | | | | | | |
| Input Differential Range | V _{ID} | Differential input | | 1.4 | | V _{P-P} |
| Common-Mode Voltage Range | V _{CMO} | | | 0.76 | | V |
| Common-Mode Voltage Range Tolerance (Note 3) | | | | ±50 | | mV |
| Differential Input Impedance | R _{IN} | Switched capacitor load | | 2 | | kΩ |
| Differential Input Capacitance | C _{IN} | | | 12.5 | | pF |
| CONVERSION RATE | | | | | | |
| Maximum Conversion Rate | f _S MAX | | 40 | | | MHz |
| Minimum Conversion Rate | f _S MIN | | | 4.0 | | MHz |
| Data Latency | | | | 6.5 | | Cycles |
| DYNAMIC CHARACTERISTICS (differential inputs, 4096-point FFT) (Note 2) | | | | | | |
| Signal-to-Noise Ratio | SNR | f _{IN} = 5.3MHz at -0.5dBFS | | 69.9 | | dB |
| | | f _{IN} = 19.3MHz at -0.5dBFS | 66.5 | 69.6 | | |
| Signal-to-Noise and Distortion (First 4 Harmonics) | SINAD | f _{IN} = 5.3MHz at -0.5dBFS | | 69.9 | | dB |
| | | f _{IN} = 19.3MHz at -0.5dBFS | 66.5 | 69.6 | | |
| Effective Number of Bits | ENOB | f _{IN} = 5.3MHz at -0.5dBFS | | 11.3 | | dB |
| | | f _{IN} = 19.3MHz at -0.5dBFS | | 11.3 | | |
| Spurious-Free Dynamic Range | SFDR | f _{IN} = 5.3MHz at -0.5dBFS | | 96 | | dBc |
| | | f _{IN} = 19.3MHz at -0.5dBFS | 79 | 90 | | |

Octal, 12-Bit, 40Mps, 1.8V ADC with Serial LVDS Outputs

MAX1436

ELECTRICAL CHARACTERISTICS (continued)

(AVDD = 1.8V, OVDD = 1.8V, CVDD = 3.3V, GND = 0, external VREFIO = 1.24V, CREFIO to GND = 0.1μF, CREFP to GND = 10μF, CREFN to GND = 10μF, fCLK = 40MHz (50% duty cycle), VDT = 0, TA = TMIN to TMAX, unless otherwise noted. Typical values are at TA = +25°C.) (Note 1)

| PARAMETER | SYMBOL | CONDITIONS | MIN | TYP | MAX | UNITS |
|--------------------------------------------------------|---------------------|----------------------------------------------------------------------------|-------------|------|------------|-------------|
| Total Harmonic Distortion | THD | f _{IN} = 5.3MHz at -0.5dBFS | | -96 | | dBc |
| | | f _{IN} = 19.3MHz at -0.5dBFS | | -92 | -79 | |
| Intermodulation Distortion | IMD | f ₁ = 5.3MHz at -6.5dBFS f ₂ = 6.3MHz at -6.5dBFS | | 89.8 | | dBc |
| Third-Order Intermodulation | IM3 | f ₁ = 5.3MHz at -6.5dBFS f ₂ = 6.3MHz at -6.5dBFS | | 96.6 | | dBc |
| Aperture Jitter | t _{AJ} | Figure 11 | | <0.4 | | psRMS |
| Aperture Delay | t _{AD} | Figure 11 | | 1 | | ns |
| Small-Signal Bandwidth | SSBW | Input at -20dBFS | | 100 | | MHz |
| Full-Power Bandwidth | LSBW | Input at -0.5dBFS | | 100 | | MHz |
| Output Noise | | IN_P = IN_N | | 0.44 | | LSBRMS |
| Over-Range Recovery Time | t _{OR} | R _S = 25Ω, C _S = 50pF | | 1 | | Clock cycle |
| INTERNAL REFERENCE | | | | | | |
| REFADJ Internal Reference-Mode Enable Voltage (Note 4) | | | | | 0.1 | V |
| REFADJ Low-Leakage Current | | | | 1.5 | | mA |
| REFIO Output Voltage | VREFIO | | 1.18 | 1.24 | 1.30 | V |
| Reference Temperature Coefficient | T _{CREFIO} | | | 120 | | ppm/°C |
| EXTERNAL REFERENCE | | | | | | |
| REFADJ External Reference-Mode Enable Voltage (Note 4) | | | AVDD - 0.1V | | | V |
| REFADJ High-Leakage Current | | | | 200 | | μA |
| REFIO Input Voltage | | | | 1.24 | | V |
| REFIO Input Voltage Tolerance | | | | ±5 | | % |
| REFIO Input Current | IREFIO | | | <1 | | μA |
| COMMON-MODE OUTPUT (CMOUT) | | | | | | |
| CMOUT Output Voltage | V _{CMOUT} | | | 0.76 | | V |
| CLOCK INPUT (CLK) | | | | | | |
| Input High Voltage | V _{CLKH} | | 0.8 x CVDD | | | V |
| Input Low Voltage | V _{CLKL} | | | | 0.2 x CVDD | V |
| Clock Duty Cycle | | | | 50 | | % |
| Clock Duty-Cycle Tolerance | | | | ±30 | | % |
| Input Leakage | DI _{IN} | Input at GND | | | 5 | μA |
| | | Input at AVDD | | | 80 | |
| Input Capacitance | DC _{IN} | | | 5 | | pF |

Octal, 12-Bit, 40MSPS, 1.8V ADC with Serial LVDS Outputs

ELECTRICAL CHARACTERISTICS (continued)

(AVDD = 1.8V, OVDD = 1.8V, CVDD = 3.3V, GND = 0, external VREFIO = 1.24V, CREFFIO to GND = 0.1μF, CREFFP to GND = 10μF, CREFN to GND = 10μF, fCLK = 40MHz (50% duty cycle), VDT = 0, TA = TMIN to TMAX, unless otherwise noted. Typical values are at TA = +25°C.) (Note 1)

| PARAMETER | SYMBOL | CONDITIONS | MIN | TYP | MAX | UNITS | |
|---------------------------------------------------------------------------------------------|----------------------|------------------------------------------------------------------------|---------------------------------------|-----|---------------|-------|----|
| DIGITAL INPUTS (PLL_, LVDSTEST, DT, SLVS, PD, T/B) | | | | | | | |
| Input High Threshold | V _{IH} | | 0.8 x AVDD | | | V | |
| Input Low Threshold | V _{IL} | | | | 0.2 x AVDD | V | |
| Input Leakage | D _{IIN} | Input at GND | | | 5 | μA | |
| | | Input at AVDD | | | 80 | | |
| Input Capacitance | DC _{IN} | | | 5 | | pF | |
| LVDS OUTPUTS (OUT_P, OUT_N), SLVS/LVDS = 0 | | | | | | | |
| Differential Output Voltage | VOHDIFF | R _{TERM} = 100Ω | 250 | | 450 | mV | |
| Output Common-Mode Voltage | V _{OCM} | R _{TERM} = 100Ω | 1.125 | | 1.375 | V | |
| Rise Time (20% to 80%) | t _{RL} | R _{TERM} = 100Ω, C _{LOAD} = 5pF | | 350 | | ps | |
| Fall Time (80% to 20%) | t _{FL} | R _{TERM} = 100Ω, C _{LOAD} = 5pF | | 350 | | ps | |
| SLVS OUTPUTS (OUT_P, OUT_N, CLKOUTP, CLKOUTN, FRAMEP, FRAMEN), SLVS/LVDS = 1, DT = 1 | | | | | | | |
| Differential Output Voltage | VOHDIFF | R _{TERM} = 100Ω | | 205 | | mV | |
| Output Common-Mode Voltage | V _{OCM} | R _{TERM} = 100Ω | | 220 | | V | |
| Rise Time (20% to 80%) | t _{RS} | R _{TERM} = 100Ω, C _{LOAD} = 5pF | | 320 | | ps | |
| Fall Time (80% to 20%) | t _{FS} | R _{TERM} = 100Ω, C _{LOAD} = 5pF | | 320 | | ps | |
| POWER-DOWN | | | | | | | |
| PD Fall to Output Enable | t _{ENABLE} | (Note 5) | | 100 | | ms | |
| PD Rise to Output Disable | t _{DISABLE} | | | 20 | | ns | |
| POWER REQUIREMENTS | | | | | | | |
| AVDD Supply Voltage Range | AVDD | | 1.7 | 1.8 | 1.9 | V | |
| OVDD Supply Voltage Range | OVDD | | 1.7 | 1.8 | 1.9 | V | |
| CVDD Supply Voltage Range | CVDD | | 1.7 | 1.8 | 3.6 | V | |
| AVDD Supply Current | I _{AVDD} | f _{IN} = 19.3MHz at -0.5dBFS | PD = 0 | | 337 | 380 | mA |
| | | | PD = 0, DT = 1 | | 337 | | |
| | | | PD = 1, power-down, no clock input | | 1.17 | | mA |
| OVDD Supply Current | I _{OVDD} | f _{IN} = 19.3MHz at -0.5dBFS | PD = 0 | | 76 | 100 | mA |
| | | | PD = 0, DT = 1 | | 99 | | |
| | | | PD = 1, power-down, no clock input | | 1.1 | | mA |
| CVDD Supply Current | I _{CVDD} | CVDD is used only to bias ESD-protection diodes on CLK input, Figure 2 | | 0 | | mA | |
| Power Dissipation | P _{DISS} | f _{IN} = 19.3MHz at -0.5dBFS | | 743 | 864 | mW | |

Octal, 12-Bit, 40Mps, 1.8V ADC with Serial LVDS Outputs

MAX1436

ELECTRICAL CHARACTERISTICS (continued)

(AVDD = 1.8V, OVDD = 1.8V, CVDD = 3.3V, GND = 0, external VREFIO = 1.24V, CREFIO to GND = 0.1μF, CREFP to GND = 10μF, CREFN to GND = 10μF, fCLK = 40MHz (50% duty cycle), VDT = 0, TA = TMIN to TMAX, unless otherwise noted. Typical values are at TA = +25°C.) (Note 1)

| PARAMETER | SYMBOL | CONDITIONS | MIN | TYP | MAX | UNITS |
|-----------------------------------------|--------|--------------|-----------------------|----------------|-----------------------|---------|
| TIMING CHARACTERISTICS (Note 6) | | | | | | |
| Data Valid to CLKOUT Rise/Fall (Note 7) | tOD | Figure 5 | (tSAMPLE / 24) - 0.15 | (tSAMPLE / 24) | (tSAMPLE / 24) + 0.15 | ns |
| CLKOUT Output-Width High | tCH | Figure 5 | | tSAMPLE / 12 | | ns |
| CLKOUT Output-Width Low | tCL | Figure 5 | | tSAMPLE / 12 | | ns |
| FRAME Rise to CLKOUT Rise (Note 7) | tCF | Figure 4 | (tSAMPLE / 24) - 0.15 | (tSAMPLE / 24) | (tSAMPLE / 24) + 0.15 | ns |
| Sample CLK Rise to FRAME Rise (Note 7) | tSF | Figure 4 | (tSAMPLE / 2) + 1.1 | (tSAMPLE / 2) | (tSAMPLE / 2) + 2.6 | ns |
| Crosstalk (Note 2) | | | | -95 | | dB |
| Gain Matching (Note 2) | CGM | fIN = 5.3MHz | | ±0.1 | | dB |
| Phase Matching (Note 2) | CPM | fIN = 5.3MHz | | ±0.25 | | degrees |

Note 1: Specifications at TA ≥ +25°C are guaranteed by production testing. Specifications at TA < +25°C are guaranteed by design and characterization and not subject to production testing.

Note 2: See definition in the *Parameter Definition* section at the end of this data sheet.

Note 3: See the *Common-Mode Output (CMOUT)* section.

Note 4: Connect REFADJ to GND directly to enable internal reference mode. Connect REFADJ to AVDD directly to disable the internal bandgap reference and enable external reference mode.

Note 5: Measured using CREFP to GND = 1μF and CREFN to GND = 1μF. tENABLE time may be lowered by using smaller capacitor values.

Note 6: Data valid to CLKOUT rise/fall timing is measured from 50% of data output level to 50% of clock output level.

Note 7: Guaranteed by design and characterization. Not subject to production testing.

Typical Operating Characteristics

(AVDD = 1.8V, OVDD = 1.8V, CVDD = 3.3V, GND = 0, internal reference, differential input at -0.5dBFS, fIN = 5.3MHz, fCLK = 40MHz (50% duty cycle), VDT = 0, CLOAD = 10pF, TA = +25°C, unless otherwise noted.)

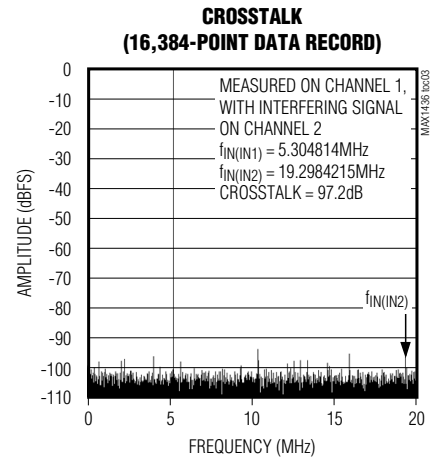
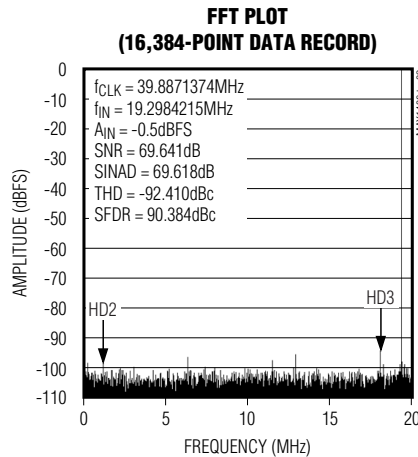
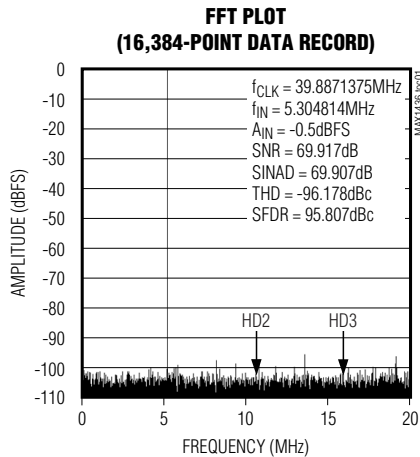

Octal, 12-Bit, 40Mps, 1.8V ADC with Serial LVDS Outputs

Typical Operating Characteristics (continued)

($V_{DD} = 1.8V$, $OV_{DD} = 1.8V$, $CV_{DD} = 3.3V$, $GND = 0$, internal reference, differential input at $-0.5dBFS$, $f_{IN} = 5.3MHz$, $f_{CLK} = 40MHz$ (50% duty cycle), $V_{DT} = 0$, $C_{LOAD} = 10pF$, $T_A = +25^{\circ}C$, unless otherwise noted.)

TWO-TONE INTERMODULATION DISTORTION (16,384-POINT DATA RECORD)

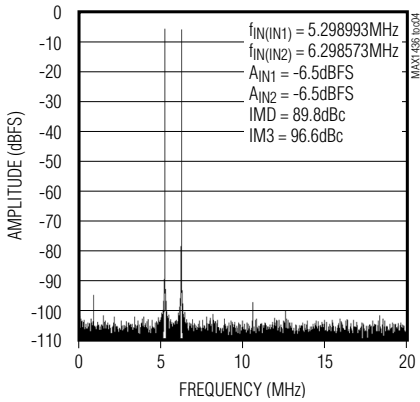

BANDWIDTH vs. ANALOG INPUT FREQUENCY

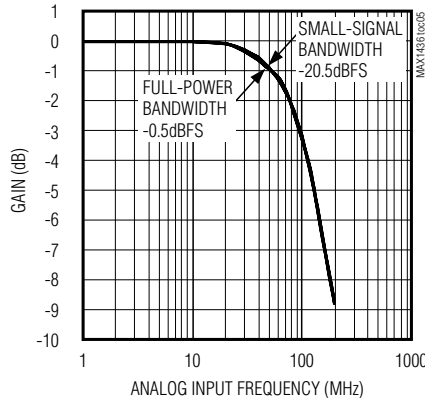

SIGNAL-TO-NOISE RATIO vs. ANALOG INPUT FREQUENCY

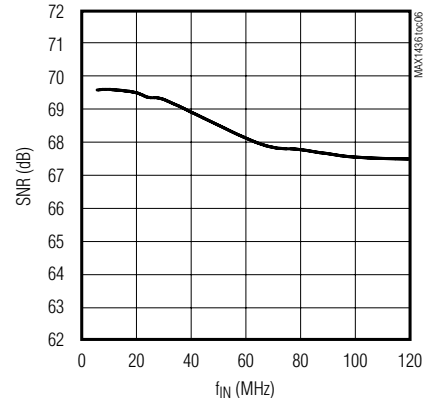

SIGNAL-TO-NOISE PLUS DISTORTION vs. ANALOG INPUT FREQUENCY

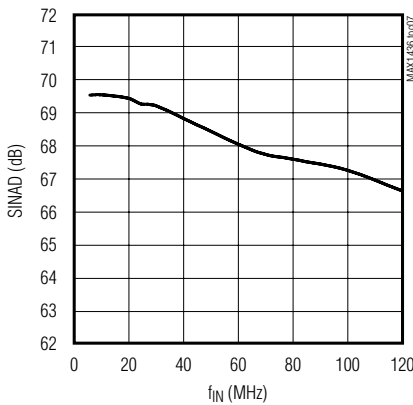

TOTAL HARMONIC DISTORTION vs. ANALOG INPUT FREQUENCY

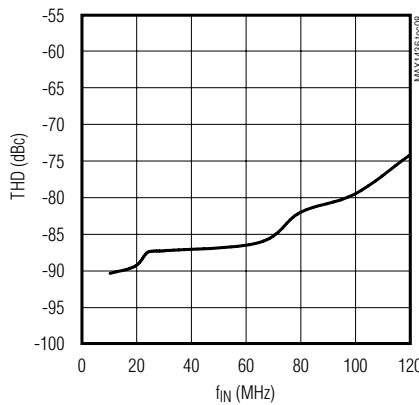

SPURIOUS-FREE DYNAMIC RANGE vs. ANALOG INPUT FREQUENCY

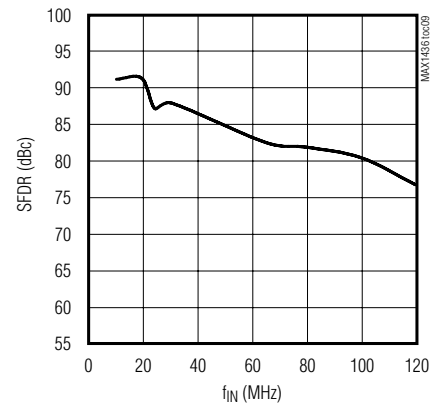

SIGNAL-TO-NOISE RATIO vs. ANALOG INPUT POWER

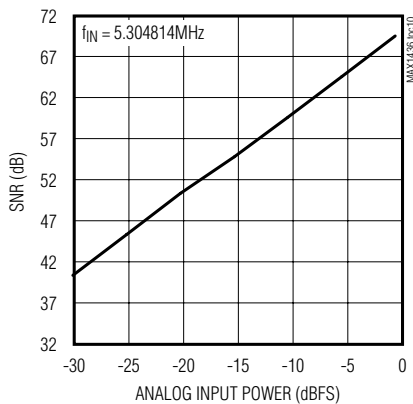

SIGNAL-TO-NOISE PLUS DISTORTION vs. ANALOG INPUT POWER

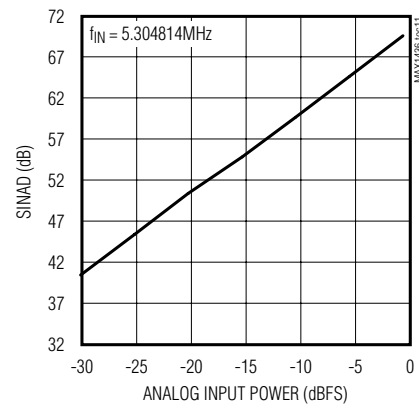

TOTAL HARMONIC DISTORTION vs. ANALOG INPUT POWER

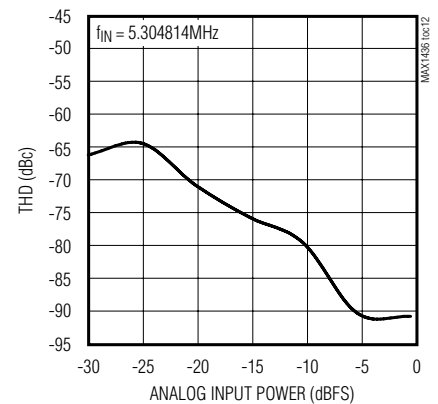

Octal, 12-Bit, 40Mps, 1.8V ADC with Serial LVDS Outputs

MAX1436

Typical Operating Characteristics (continued)

(AVDD = 1.8V, OVDD = 1.8V, CVDD = 3.3V, GND = 0, internal reference, differential input at -0.5dBFS, f_{IN} = 5.3MHz, f_{CLK} = 40MHz (50% duty cycle), V_{DT} = 0, C_{LOAD} = 10pF, T_A = +25°C, unless otherwise noted.)

SPURIOUS-FREE DYNAMIC RANGE vs. ANALOG INPUT POWER

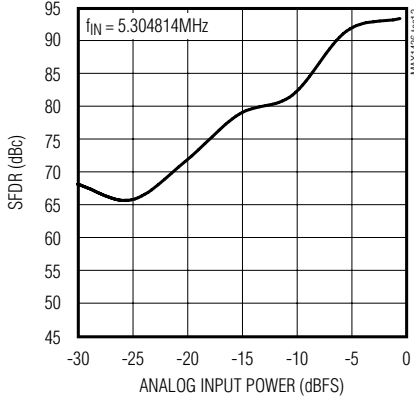

SIGNAL-TO-NOISE RATIO vs. SAMPLING RATE

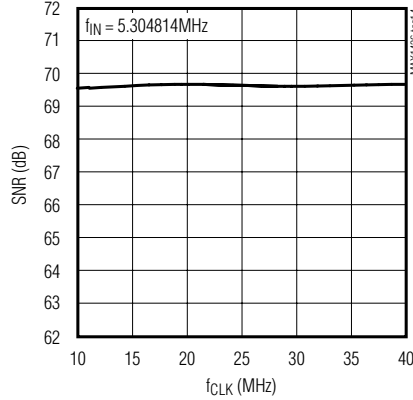

SIGNAL-TO-NOISE PLUS DISTORTION vs. SAMPLING RATE

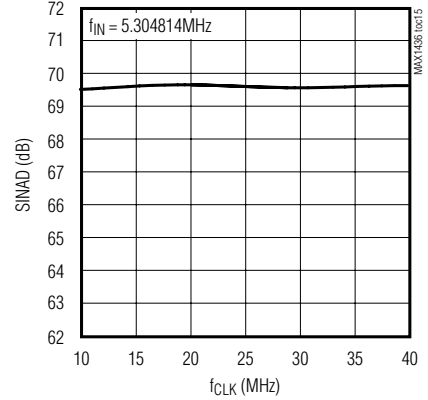

TOTAL HARMONIC DISTORTION vs. SAMPLING RATE

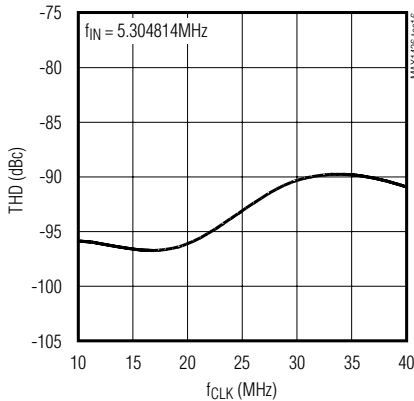

SPURIOUS-FREE DYNAMIC RANGE vs. SAMPLING RATE

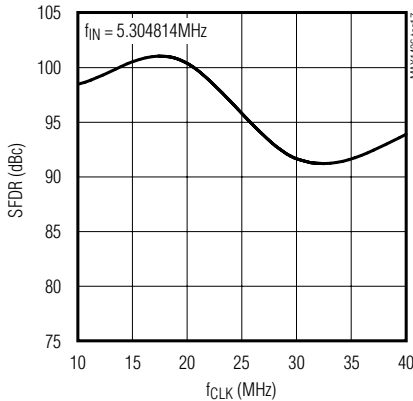

SIGNAL-TO-NOISE RATIO vs. DUTY CYCLE

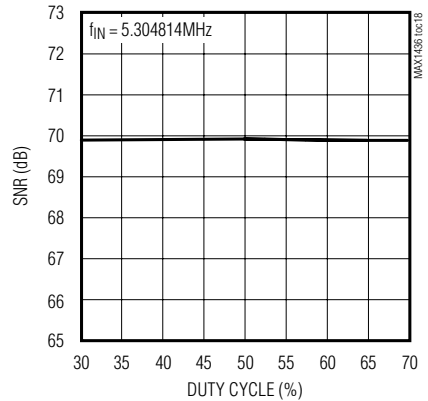

SIGNAL-TO-NOISE PLUS DISTORTION vs. DUTY CYCLE

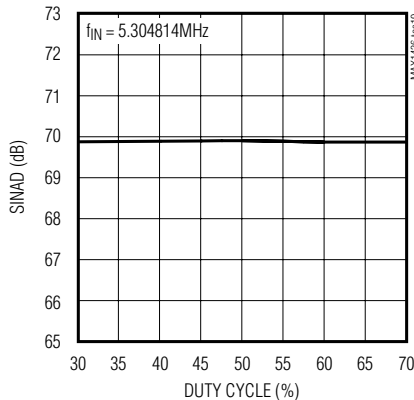

TOTAL HARMONIC DISTORTION vs. DUTY CYCLE

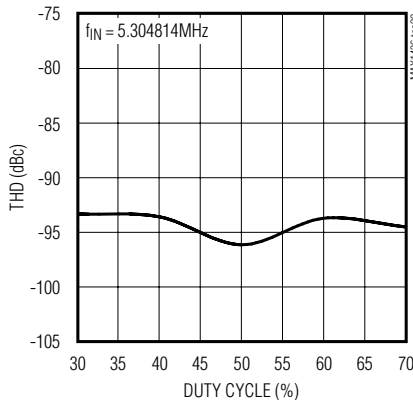

SPURIOUS-FREE DYNAMIC RANGE vs. DUTY CYCLE

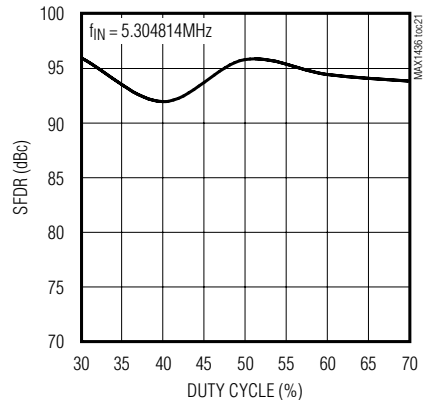

Octal, 12-Bit, 40Mps, 1.8V ADC with Serial LVDS Outputs

Typical Operating Characteristics (continued)

(AVDD = 1.8V, OVDD = 1.8V, CVDD = 3.3V, GND = 0, internal reference, differential input at -0.5dBFS, fIN = 5.3MHz, fCLK = 40MHz (50% duty cycle), VDT = 0, CLOAD = 10pF, TA = +25°C, unless otherwise noted.)

SIGNAL-TO-NOISE RATIO vs. TEMPERATURE

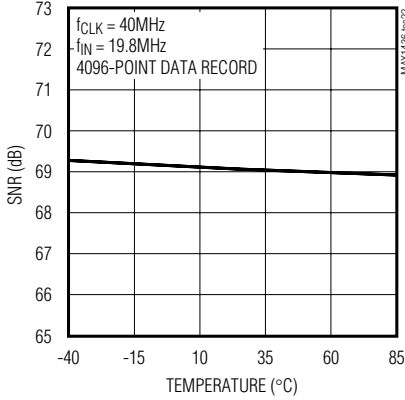

SIGNAL-TO-NOISE PLUS DISTORTION vs. TEMPERATURE

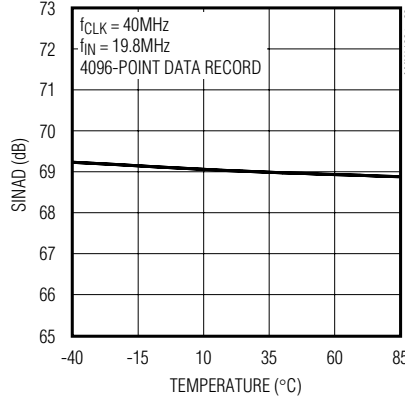

TOTAL HARMONIC DISTORTION vs. TEMPERATURE

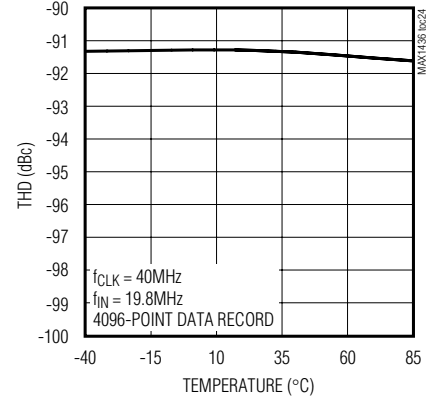

SPURIOUS-FREE DYNAMIC RANGE vs. TEMPERATURE

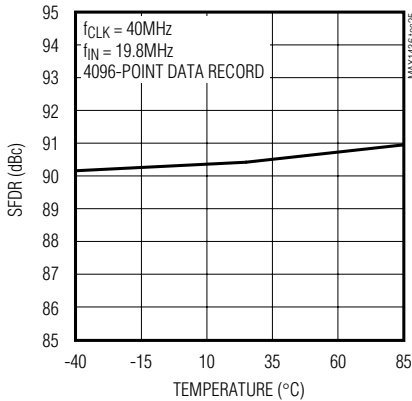

SUPPLY CURRENT vs. SAMPLING RATE (AVDD)

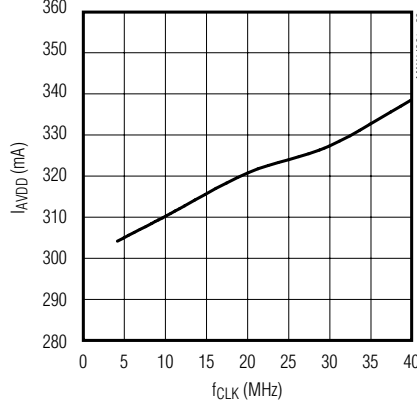

ANALOG SUPPLY CURRENT vs. SAMPLING RATE (OVDD)

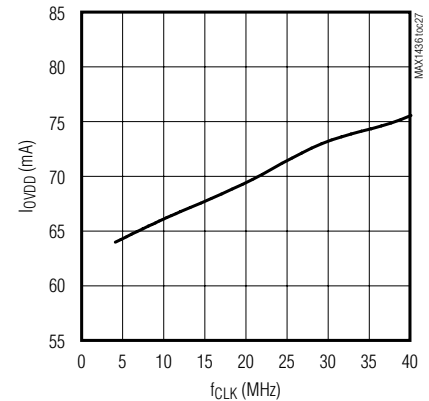

OFFSET ERROR vs. TEMPERATURE

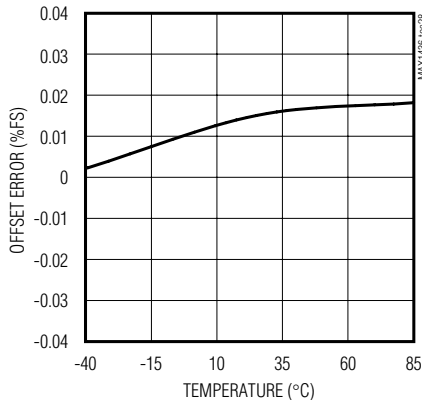

GAIN ERROR vs. TEMPERATURE

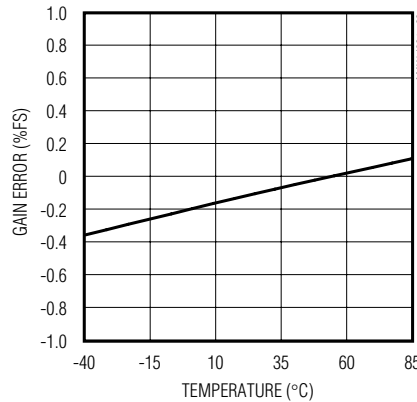

INTEGRAL NONLINEARITY vs. DIGITAL OUTPUT CODE

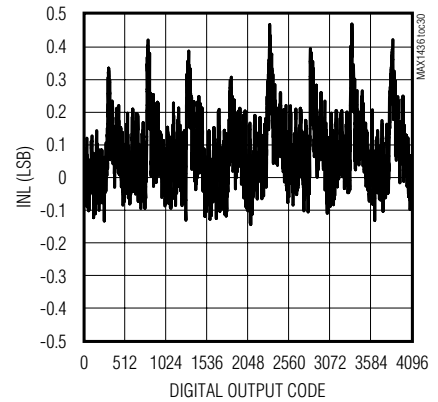

Octal, 12-Bit, 40Mps, 1.8V ADC with Serial LVDS Outputs

MAX1436

Typical Operating Characteristics (continued)

($V_{DD} = 1.8V$, $OV_{DD} = 1.8V$, $CV_{DD} = 3.3V$, $GND = 0$, internal reference, differential input at $-0.5dBFS$, $f_{IN} = 5.3MHz$, $f_{CLK} = 40MHz$ (50% duty cycle), $V_{DT} = 0$, $C_{LOAD} = 10pF$, $T_A = +25^\circ C$, unless otherwise noted.)

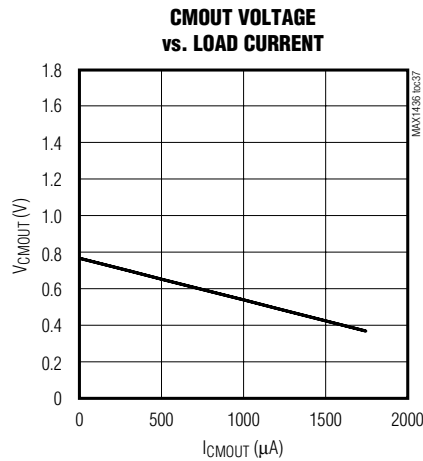
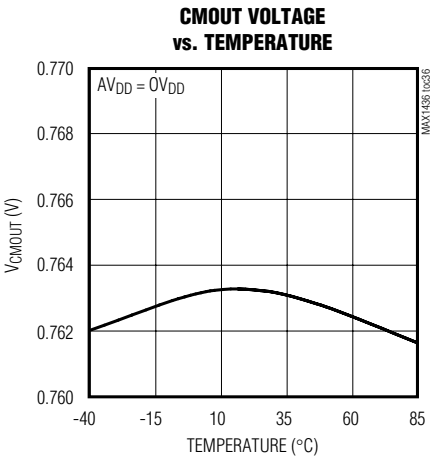
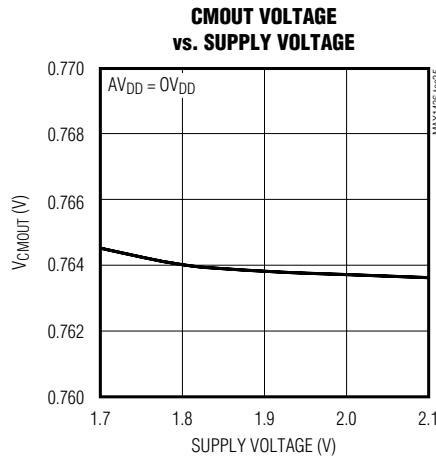
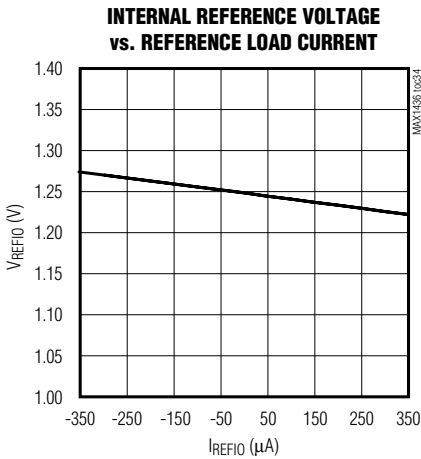
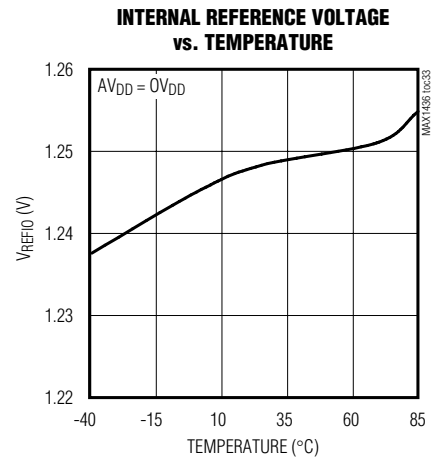
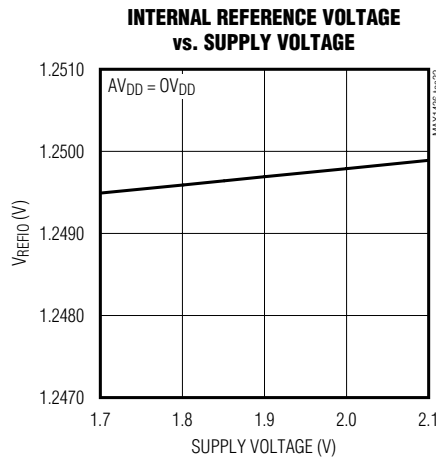
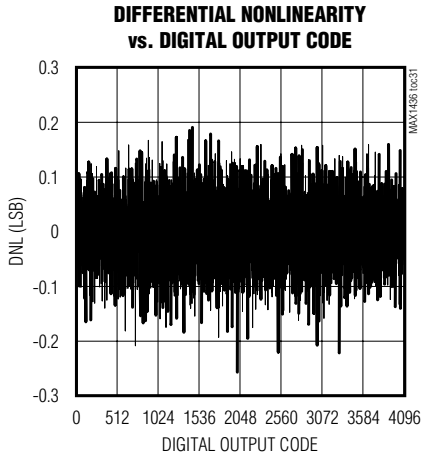

Octal, 12-Bit, 40Msps, 1.8V ADC with Serial LVDS Outputs

Pin Description

| PIN | NAME | FUNCTION |
|------------------------------------------------------------------|--------------------------------|---------------------------------------------------------------------------------------------------------------------------------------------------------------------------------------------------------------------------------------------------------------------------------------------------------------------------------|
| 1, 4, 7, 10, 16, 19, 22, 25, 26, 27, 30, 36, 89, 92, 96, 99, 100 | GND | Ground. Connect all GND pins to the same potential. |
| 2 | IN1P | Channel 1 Positive Analog Input |
| 3 | IN1N | Channel 1 Negative Analog Input |
| 5 | IN2P | Channel 2 Positive Analog Input |
| 6 | IN2N | Channel 2 Negative Analog Input |
| 8 | IN3P | Channel 3 Positive Analog Input |
| 9 | IN3N | Channel 3 Negative Analog Input |
| 11, 12, 13, 15, 37–42, 86, 87, 88 | AV _{DD} | Analog Power Input. Connect AV _{DD} to a +1.7V to +1.9V power supply. Bypass AV _{DD} to GND with a 0.1μF capacitor as close to the device as possible. Bypass the AV _{DD} power plane to the GND plane with a bulk ≥2.2μF capacitor. Connect all AV _{DD} pins to the same potential. |
| 14, 31, 50, 51, 70, 75, 76 | N.C. | No Connection. Not internally connected. |
| 17 | IN4P | Channel 4 Positive Analog Input |
| 18 | IN4N | Channel 4 Negative Analog Input |
| 20 | IN5P | Channel 5 Positive Analog Input |
| 21 | IN5N | Channel 5 Negative Analog Input |
| 23 | IN6P | Channel 6 Positive Analog Input |
| 24 | IN6N | Channel 6 Negative Analog Input |
| 28 | IN7P | Channel 7 Positive Analog Input |
| 29 | IN7N | Channel 7 Negative Analog Input |
| 32 | DT | Double-Termination Select. Drive DT high to select the internal 100Ω termination between the differential output pairs. Drive DT low to select no output termination. |
| 33 | SLVS/ $\overline{\text{LVDS}}$ | Differential Output-Signal Format-Select Input. Drive SLVS/ $\overline{\text{LVDS}}$ high to select SLVS outputs. Drive SLVS/ $\overline{\text{LVDS}}$ low to select LVDS outputs. |
| 34 | CV _{DD} | Clock Power Input. Connect CV _{DD} to a +1.7V to +3.6V supply. Bypass CV _{DD} to GND with a 0.1μF capacitor in parallel with a ≥2.2μF capacitor. Install the bypass capacitors as close to the device as possible. |
| 35 | CLK | Single-Ended CMOS Clock Input |
| 43, 46, 49, 54, 57, 60, 63, 64, 67, 71, 74, 77 | OV _{DD} | Output-Driver Power Input. Connect OV _{DD} to a +1.7V to +1.9V power supply. Bypass OV _{DD} to GND with a 0.1μF capacitor as close to the device as possible. Bypass the OV _{DD} power plane to the GND plane with a bulk ≥2.2μF capacitor. Connect all OV _{DD} pins to the same potential. |
| 44 | OUT7N | Channel 7 Negative LVDS/SLVS Output |
| 45 | OUT7P | Channel 7 Positive LVDS/SLVS Output |
| 47 | OUT6N | Channel 6 Negative LVDS/SLVS Output |
| 48 | OUT6P | Channel 6 Positive LVDS/SLVS Output |
| 52 | OUT5N | Channel 5 Negative LVDS/SLVS Output |
| 53 | OUT5P | Channel 5 Positive LVDS/SLVS Output |
| 55 | OUT4N | Channel 4 Negative LVDS/SLVS Output |
| 56 | OUT4P | Channel 4 Positive LVDS/SLVS Output |

Octal, 12-Bit, 40Mps, 1.8V ADC with Serial LVDS Outputs

Pin Description (continued)

MAX1436

| PIN | NAME | FUNCTION |
|-----|-------------|-------------------------------------------------------------------------------------------------------------------------------------------------------------------------------------------------------------------------------------------------------------------------------------------------------------------------------------|
| 58 | FRAMEN | Negative Frame-Alignment LVDS/SLVS Output. A rising edge on the differential FRAME output aligns to a valid D0 in the output data stream. |
| 59 | FRAMEP | Positive Frame-Alignment LVDS/SLVS Output. A rising edge on the differential FRAME output aligns to a valid D0 in the output data stream. |
| 61 | CLKOUTN | Negative LVDS/SLVS Serial Clock Output |
| 62 | CLKOUTP | Positive LVDS/SLVS Serial Clock Output |
| 65 | OUT3N | Channel 3 Negative LVDS/SLVS Output |
| 66 | OUT3P | Channel 3 Positive LVDS/SLVS Output |
| 68 | OUT2N | Channel 2 Negative LVDS/SLVS Output |
| 69 | OUT2P | Channel 2 Positive LVDS/SLVS Output |
| 72 | OUT1N | Channel 1 Negative LVDS/SLVS Output |
| 73 | OUT1P | Channel 1 Positive LVDS/SLVS Output |
| 78 | OUT0N | Channel 0 Negative LVDS/SLVS Output |
| 79 | OUT0P | Channel 0 Positive LVDS/SLVS Output |
| 80 | LVDSTEST | LVDS Test Pattern Enable. Drive LVDSTEST high to enable the output test pattern (0000 1011 1101 MSB→ LSB). As with the analog conversion results, the test pattern data is output LSB first. Drive LVDSTEST low for normal operation. |
| 81 | PD | Power-Down Input. Drive PD high to power down all channels and reference. Drive PD low for normal operation. |
| 82 | PLL3 | PLL Control Input 3. See Table 1 for details. |
| 83 | PLL2 | PLL Control Input 2. See Table 1 for details. |
| 84 | PLL1 | PLL Control Input 1. See Table 1 for details. |
| 85 | \bar{T}/B | Output Format-Select Input. Drive \bar{T}/B high to select binary output format. Drive \bar{T}/B low to select two's-complement output format. |
| 90 | REFN | Negative Reference Bypass Output. Connect a $\geq 1\mu\text{F}$ (10 μF typ) capacitor between REFP and REFN, and connect a $\geq 1\mu\text{F}$ (10 μF typ) capacitor between REFN and GND. Place the capacitors as close to the device as possible on the same side of the printed circuit (PC) board. |
| 91 | REFP | Positive Reference Bypass Output. Connect a $\geq 1\mu\text{F}$ (10 μF typ) capacitor between REFP and REFN, and connect a $\geq 1\mu\text{F}$ (10 μF typ) capacitor between REFP and GND. Place the capacitors as close to the device as possible on the same side of the PC board. |
| 93 | REFIO | Reference Input/Output. For internal reference operation (REFADJ = GND), the reference output voltage is 1.24V. For external reference operation (REFADJ = AV _{DD}), apply a stable reference voltage at REFIO. Bypass to GND with $\geq 0.1\mu\text{F}$. |
| 94 | REFADJ | Internal/External Reference-Mode-Select and Reference Adjust Input. For internal reference mode, connect REFADJ directly to GND. For external reference mode, connect REFADJ directly to AV _{DD} . For reference-adjust mode, see the <i>Full-Scale Range Adjustments Using the Internal Reference</i> section. |
| 95 | CMOUT | Common-Mode Reference Voltage Output. CMOUT outputs the input common-mode voltage for DC-coupled applications. Bypass CMOUT to GND with $\geq 0.1\mu\text{F}$ capacitor. |
| 97 | IN0P | Channel 0 Positive Analog Input |
| 98 | IN0N | Channel 0 Negative Analog Input |
| — | EP | Exposed Paddle. EP is internally connected to GND. Connect EP to GND. |

Octal, 12-Bit, 40MSPS, 1.8V ADC with Serial LVDS Outputs

Functional Diagram

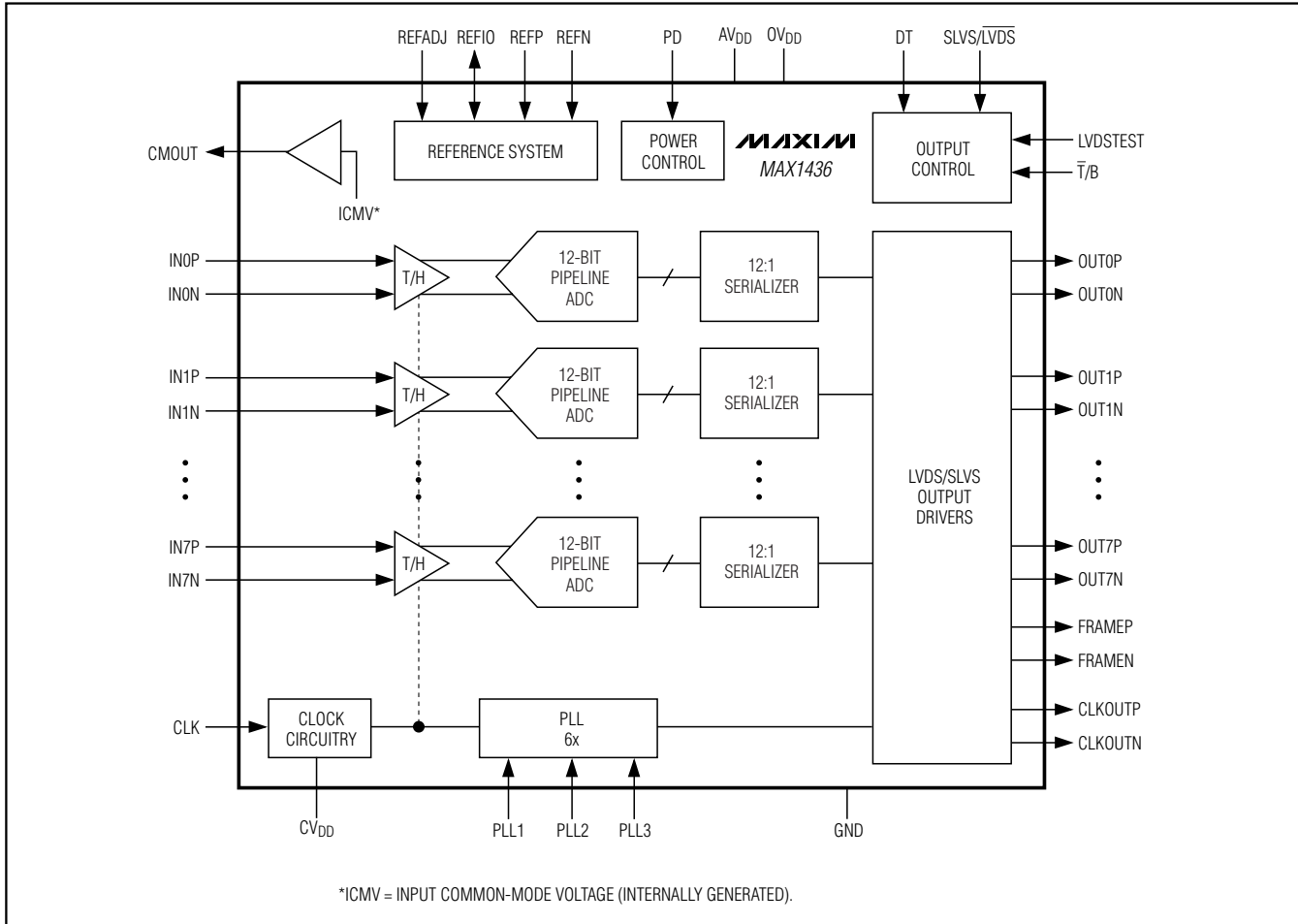

Detailed Description

The MAX1436 ADC features fully differential inputs, a pipelined architecture, and digital error correction for high-speed signal conversion. The ADC pipeline architecture moves the samples taken at the inputs through the pipeline stages every half clock cycle. The converted digital results are serialized and sent through the LVDS/SLVS output drivers. The total clock-cycle latency from input to output is 6.5 clock cycles.

The MAX1436 offers eight separate fully differential channels with synchronized inputs and outputs. Configure the outputs for binary or two's complement with the \bar{T}/B digital input. Global power-down minimizes power consumption.

Input Circuit

Figure 1 displays a simplified diagram of the input T/H circuits. In track mode, switches S1, S2a, S2b, S4a, S4b, S5a, and S5b are closed. The fully differential circuits sample the input signals onto the two capacitors (C2a and C2b) through switches S4a and S4b. S2a and S2b set the common mode for the operational transconductance amplifier (OTA), and open simultaneously with S1, sampling the input waveform. Switches S4a, S4b, S5a, and S5b are then opened before switches S3a and S3b connect capacitors C1a and C1b to the output of the amplifier and switch S4c is closed. The resulting differential voltages are held on capacitors C2a and C2b. The amplifiers charge capacitors C1a and C1b to the same values originally held on C2a and C2b. These values are

Octal, 12-Bit, 40MSPS, 1.8V ADC with Serial LVDS Outputs

MAX1436

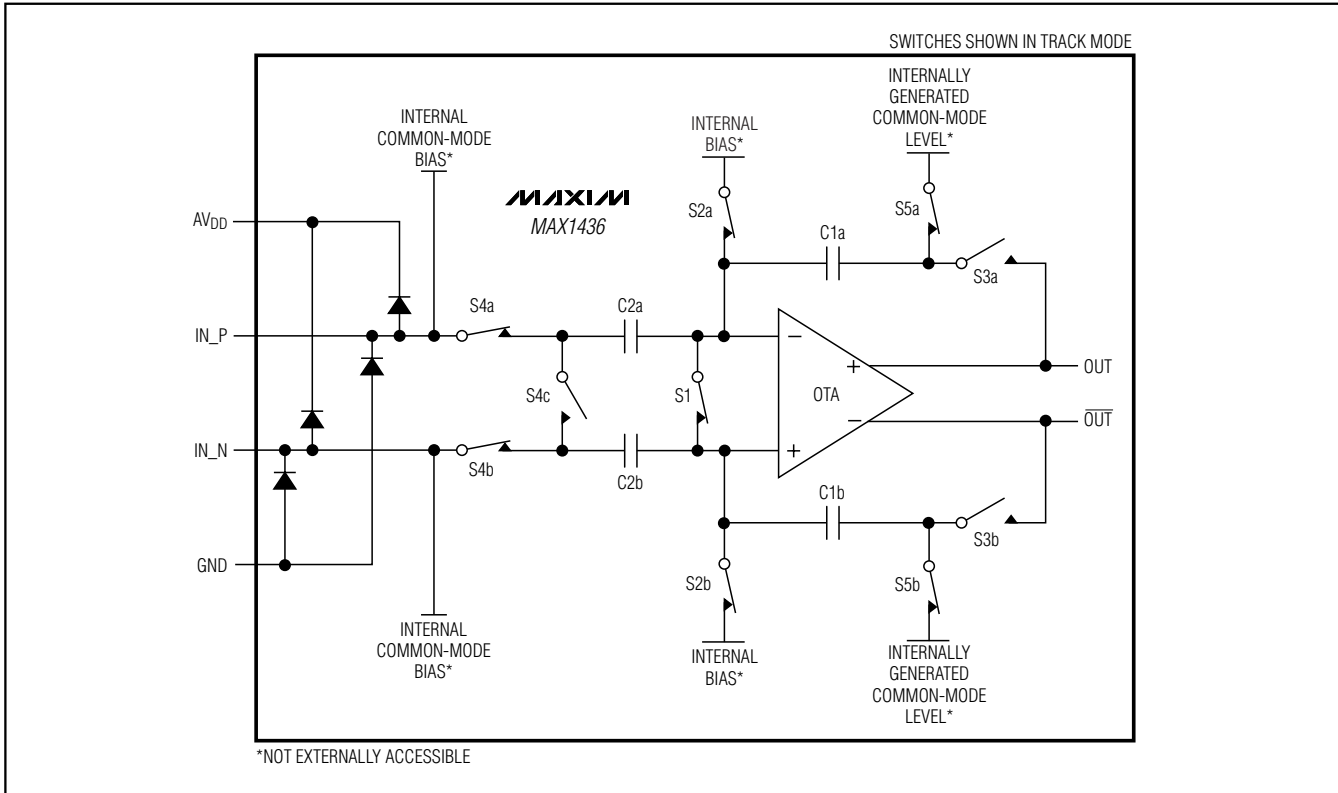

Figure 1. Internal Input Circuit

then presented to the first-stage quantizers and isolate the pipelines from the fast-changing inputs. Analog inputs, IN_P to IN_N, are driven differentially. For differential inputs, balance the input impedance of IN_P and IN_N for optimum performance.

Reference Configurations (REFIO, REFADJ, REFP, and REFN)

The MAX1436 provides an internal 1.24V bandgap reference or can be driven with an external reference voltage. The full-scale analog differential input range is \pm FSR. FSR (full-scale range) is given by the following equation:

$$FSR = \frac{(0.700 \times V_{REFIO})}{1.24V}$$

where V_{REFIO} is the voltage at REFIO, generated internally or externally. For a $V_{REFIO} = 1.24V$, the full-scale input range is $\pm 700mV$ ($1.4V_{P-P}$).

Internal Reference Mode

Connect REFADJ to GND to use the internal bandgap reference directly. The internal bandgap reference generates V_{REFIO} to be 1.24V with a 120ppm/°C temperature coefficient in internal reference mode. Connect an external $\geq 0.1\mu F$ bypass capacitor from REFIO to GND for stability. REFIO sources up to 200 μA and sinks up to 200 μA for external circuits, and REFIO has a 75mV/mA load regulation. REFIO has $> 1M\Omega$ to GND when the MAX1436 is in power-down mode. The internal reference circuit requires 100ms (C_{REFP} to GND = C_{REFN} to GND = 1 μF) to power up and settle when power is applied to the MAX1436 or when PD transitions from high to low.

To compensate for gain errors or to decrease or increase the ADC's FSR, add an external resistor between REFADJ and GND or REFADJ and REFIO. This adjusts the internal reference value of the MAX1436 by up to $\pm 5\%$ of its nominal value. See the *Full-Scale Range Adjustments Using the Internal Reference* section.

Octal, 12-Bit, 40Msps, 1.8V ADC with Serial LVDS Outputs

Connect $\geq 1\mu\text{F}$ ($10\mu\text{F}$ typ) capacitors to GND from REFP and REFN and a $\geq 1\mu\text{F}$ ($10\mu\text{F}$ typ) capacitor between REFP and REFN as close to the device as possible on the same side of the PC board.

External Reference Mode

The external reference mode allows for more control over the MAX1436 reference voltage and allows multiple converters to use a common reference. Connect REFADJ to AVDD to disable the internal reference. Apply a stable 1.18V to 1.30V source at REFIO. Bypass REFIO to GND with a $\geq 0.1\mu\text{F}$ capacitor. The REFIO input impedance is $>1\text{M}\Omega$.

Clock Input (CLK)

The MAX1436 accepts a CMOS-compatible clock signal with a wide 20% to 80% input clock duty cycle. Drive CLK with an external single-ended clock signal. Figure 2 shows the simplified clock input diagram.

Low clock jitter is required for the specified SNR performance of the MAX1436. Analog input sampling occurs on the rising edge of CLK, requiring this edge to provide the lowest possible jitter. Jitter limits the maximum SNR performance of any ADC according to the following relationship:

$$\text{SNR} = 20 \times \log \left(\frac{1}{2 \times \pi \times f_{\text{IN}} \times t_{\text{J}}} \right)$$

where f_{IN} represents the analog input frequency and t_{J} is the total system clock jitter.

PLL Inputs (PLL1, PLL2, PLL3)

The MAX1436 features a PLL that generates an output clock signal with 6 times the frequency of the input clock. The output clock signal is used to clock data out of the MAX1436 (see the *System Timing Requirements* section). Set the PLL1, PLL2, and PLL3 bits according to the input clock range provided in Table 1.

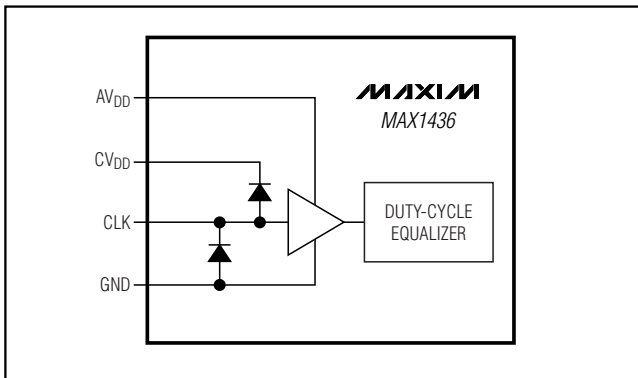

Figure 2. Clock Input Circuitry

Table 1. PLL1, PLL2, and PLL3 Configuration Table

| PLL1 | PLL2 | PLL3 | INPUT CLOCK RANGE (MHz) | |
|------|------|------|-------------------------|------|
| | | | MIN | MAX |
| 0 | 0 | 0 | Unused | |
| 0 | 0 | 1 | 32.5 | 40.0 |
| 0 | 1 | 0 | 22.5 | 32.5 |
| 0 | 1 | 1 | 16.3 | 22.5 |
| 1 | 0 | 0 | 11.3 | 16.3 |
| 1 | 0 | 1 | 8.1 | 11.3 |
| 1 | 1 | 0 | 5.6 | 8.1 |
| 1 | 1 | 1 | 4.0 | 5.6 |

System Timing Requirements

Figure 3 shows the relationship between the analog inputs, input clock, frame-alignment output, serial-clock output, and serial-data output. The differential analog input (IN_P and IN_N) is sampled on the rising edge of the CLK signal and the resulting data appears at the digital outputs 6.5 clock cycles later. Figure 4 provides a detailed, two-conversion timing diagram of the relationship between the inputs and the outputs.

Clock Output (CLKOUTP, CLKOUTN)

The MAX1436 provides a differential clock output that consists of CLKOUTP and CLKOUTN. As shown in Figure 4, the serial output data is clocked out of the MAX1436 on both edges of the clock output. The frequency of the output clock is 6 times the frequency of CLK.

Frame-Alignment Output (FRAMEP, FRAMEN)

The MAX1436 provides a differential frame-alignment signal that consists of FRAMEP and FRAMEN. As shown in Figure 4, the rising edge of the frame-alignment signal corresponds to the first bit (D0) of the 12-bit serial data stream. The frequency of the frame-alignment signal is identical to the frequency of the input clock.

Serial Output Data (OUT_P, OUT_N)

The MAX1436 provides its conversion results through individual differential outputs consisting of OUT_P and OUT_N. The results are valid 6.5 input clock cycles after the sample is taken. As shown in Figure 3, the output data is clocked out on both edges of the output clock, LSB (D0) first. Figure 5 provides the detailed serial-output timing diagram.

Octal, 12-Bit, 40Mps, 1.8V ADC with Serial LVDS Outputs

MAX1436

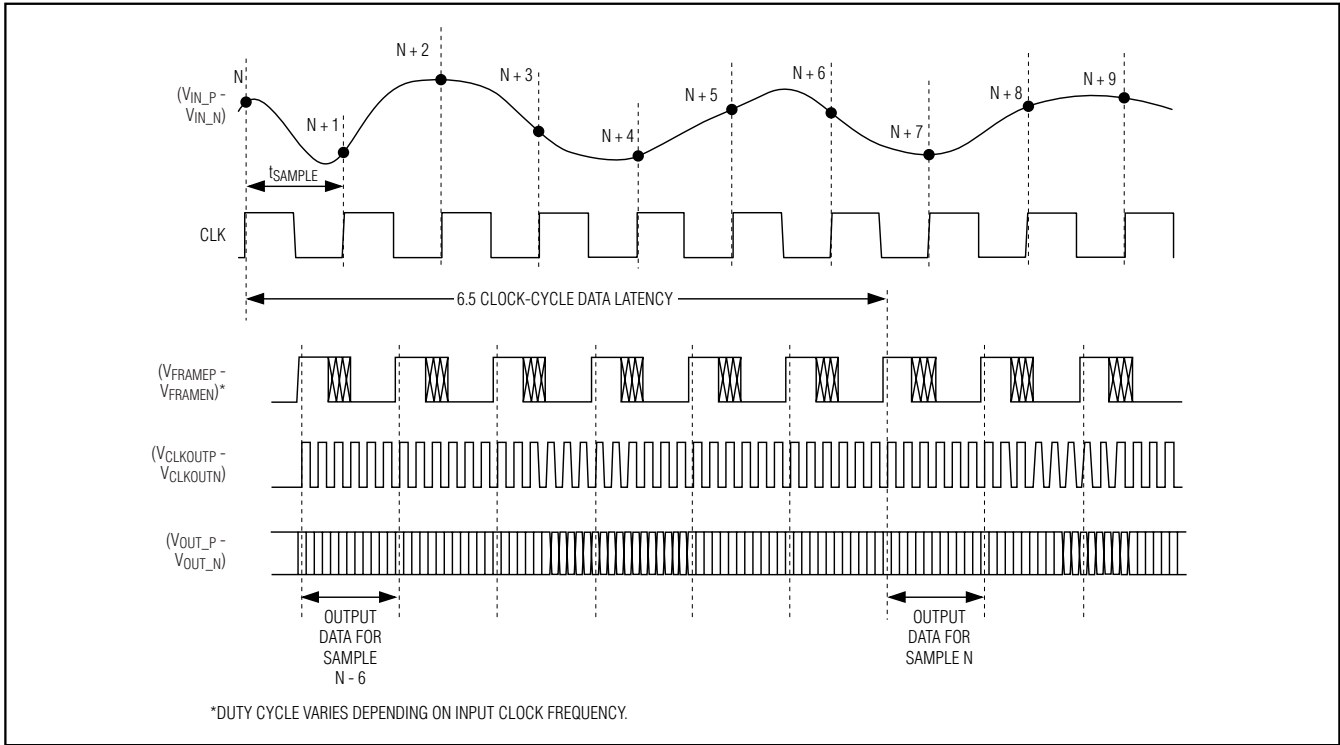

Figure 3. Global Timing Diagram

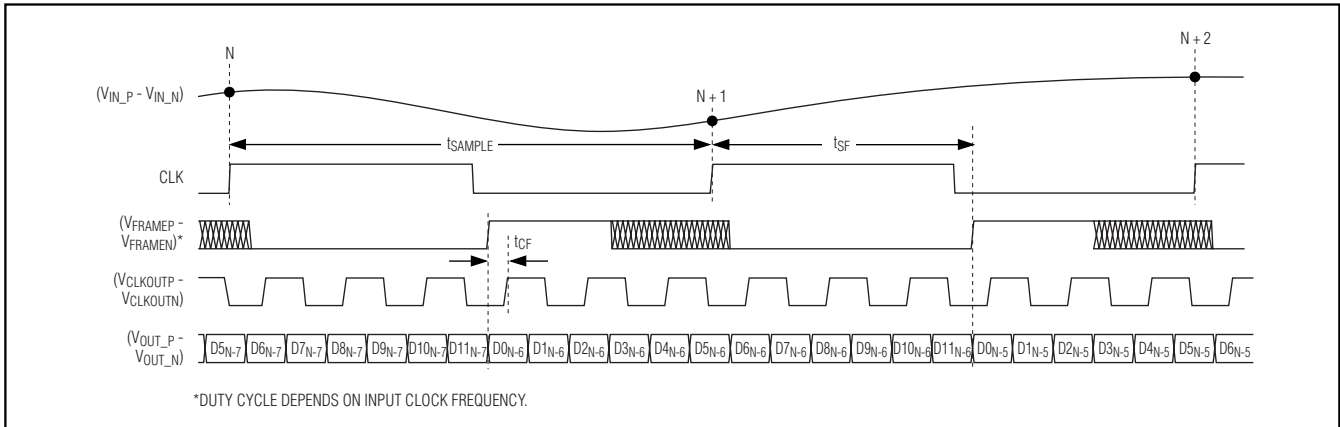

Figure 4. Detailed Two-Conversion Timing Diagram

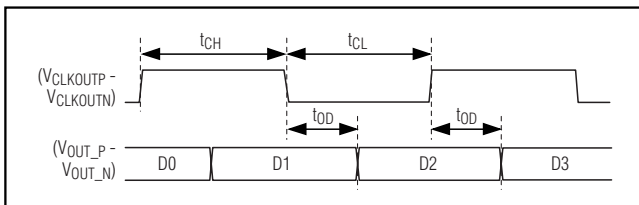

Figure 5. Serialized-Output Detailed Timing Diagram

Octal, 12-Bit, 40MSPS, 1.8V ADC with Serial LVDS Outputs

Table 2. Output Code Table (VREFIO = 1.24V)

| TWO'S-COMPLEMENT DIGITAL OUTPUT CODE ($\bar{T}/B = 0$) | | | OFFSET BINARY DIGITAL OUTPUT CODE ($\bar{T}/B = 1$) | | | VIN_P - VIN_N (mV) (VREFIO = 1.24V) |
|-------------------------------------------------------------|------------------------------------------|--------------------------------------|----------------------------------------------------------|------------------------------------------|--------------------------------------|----------------------------------------|
| BINARY D11 → D0 | HEXADECIMAL EQUIVALENT OF D11 → D0 | DECIMAL EQUIVALENT OF D11 → D0 | BINARY D11 → D0 | HEXADECIMAL EQUIVALENT OF D11 → D0 | DECIMAL EQUIVALENT OF D11 → D0 | |
| 0111 1111 1111 | 0x7FF | +2047 | 1111 1111 1111 | 0xFFF | +4095 | +699.66 |
| 0111 1111 1110 | 0x7FE | +2046 | 1111 1111 1110 | 0xFFE | +4094 | +699.32 |
| 0000 0000 0001 | 0x001 | +1 | 1000 0000 0001 | 0x801 | +2049 | +0.34 |
| 0000 0000 0000 | 0x000 | 0 | 1000 0000 0000 | 0x800 | +2048 | 0 |
| 1111 1111 1111 | 0xFFF | -1 | 0111 1111 1111 | 0x7FF | +2047 | -0.34 |
| 1000 0000 0001 | 0x801 | -2047 | 0000 0000 0001 | 0x001 | +1 | -699.66 |
| 1000 0000 0000 | 0x800 | -2048 | 0000 0000 0000 | 0x000 | 0 | -700.00 |

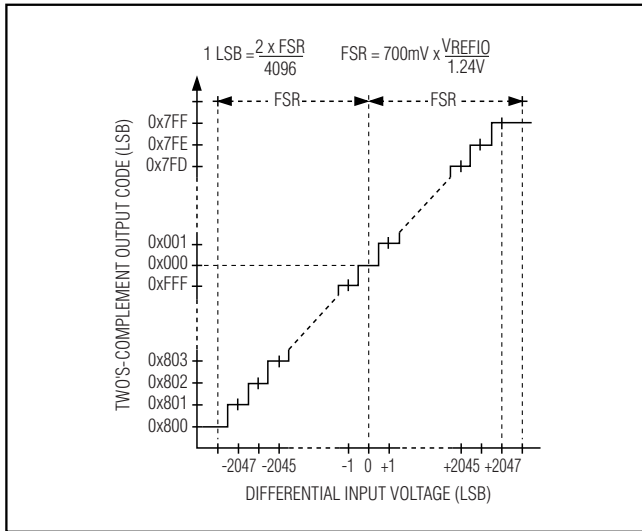

Figure 6. Two's-Complement Transfer Function ($\bar{T}/B = 0$)

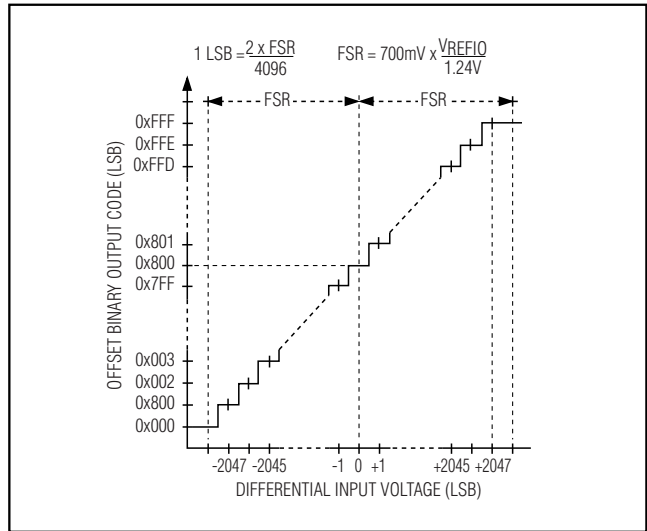

Figure 7. Binary Transfer Function ($\bar{T}/B = 1$)

Output Data Format (\bar{T}/B) Transfer Functions

The MAX1436 output data format is either offset binary or two's complement, depending on the logic-input \bar{T}/B . With \bar{T}/B low, the output data format is two's complement. With \bar{T}/B high, the output data format is offset binary. The following equations, Table 2, and Figures 6 and 7 define the relationship between the digital output and the analog input. For two's complement ($\bar{T}/B = 0$):

$$V_{IN_P} - V_{IN_N} = FSR \times 2 \times \frac{CODE_{10}}{4096}$$

and for offset binary ($\bar{T}/B = 1$):

$$V_{IN_P} - V_{IN_N} = FSR \times 2 \times \frac{CODE_{10} - 2048}{4096}$$

where $CODE_{10}$ is the decimal equivalent of the digital output code as shown in Table 2.

Keep the capacitive load on the MAX1436 digital outputs as low as possible.

Octal, 12-Bit, 40MSPS, 1.8V ADC with Serial LVDS Outputs

LVDS and SLVS Signals (SLVS/LVDS)

Drive SLVS/LVDS low for LVDS or drive SLVS/LVDS high for SLVS levels at the MAX1436 outputs (OUT_P, OUT_N, CLKOUTP, CLKOUTN, FRAMEP, and FRAMEN). For SLVS levels, enable double-termination by driving DT high. See the *Electrical Characteristics* table for LVDS and SLVS output voltage levels.

LVDS Test Pattern (LVDSTEST)

Drive LVDSTEST high to enable the output test pattern on all LVDS or SLVS output channels. The output test pattern is 0000 1011 1101. Drive LVDSTEST low for normal operation (test pattern disabled).

Common-Mode Output (CMOUT)

CMOUT provides a common-mode reference for DC-coupled analog inputs. If the input is DC-coupled, match the output common-mode voltage of the circuit driving the MAX1436 to the output voltage at VCMOUT to within $\pm 50\text{mV}$. It is recommended that the output common-mode voltage of the driving circuit be derived from CMOUT.

Double-Termination (DT)

The MAX1436 offers an optional, internal 100Ω termination between the differential output pairs (OUT_P and OUT_N, CLKOUTP and CLKOUTN, FRAMEP and FRAMEN). In addition to the termination at the end of the line, a second termination directly at the outputs helps eliminate unwanted reflections down the line. This feature is useful in applications where trace lengths are long ($>5\text{in}$) or with mismatched impedance. Drive DT high to select double-termination, or drive DT low to disconnect the internal termination resistor (single-termination). Selecting double-termination increases the OVDD supply current (see Figure 8).

Power-Down Mode (PD)

The MAX1436 offers a power-down mode to efficiently use power by transitioning to a low-power state when conversions are not required.

PD controls the power-down mode of all channels and the internal reference circuitry. Drive PD high to enable power-down. In power-down mode, the output impedance of all of the LVDS/SLVS outputs is approximately 342Ω , if DT is low. The output impedance of the differential LVDS/SLVS outputs is 100Ω when DT is high. See the *Electrical Characteristics* table for typical supply currents during power-down. The following list shows the state of the analog inputs and digital outputs in power-down mode:

- IN_P, IN_N analog inputs are disconnected from the internal input amplifier
- REFIO has $>1\text{M}\Omega$ to GND

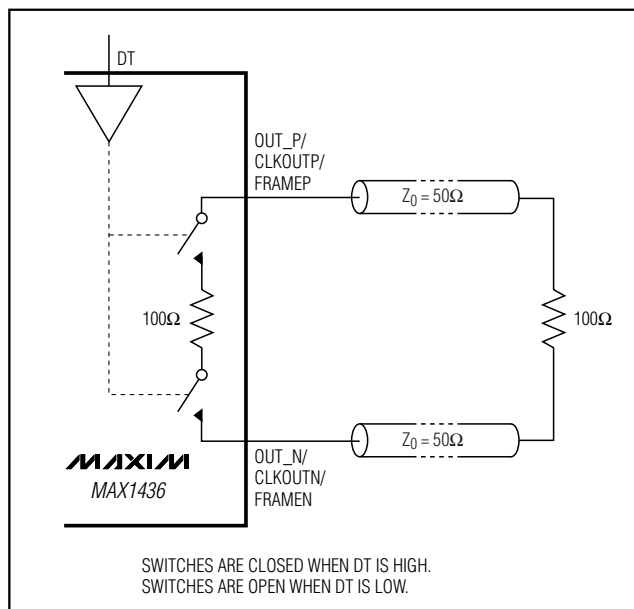

Figure 8. Double-Termination

- OUT_P, OUT_N, CLKOUTP, CLKOUTN, FRAMEP, and FRAMEN have approximately 342Ω between the output pairs when DT is low. When DT is high, the differential output pairs have 100Ω between each pair.

When operating from the internal reference, the wake-up time from power-down is typically 100ms (C_{REFP} to GND = C_{REFN} to GND = $1\mu\text{F}$). When using an external reference, the wake-up time is dependent on the external reference drivers.

Applications Information

Full-Scale Range Adjustments Using the Internal Reference

The MAX1436 supports a full-scale adjustment range of 10% ($\pm 5\%$). To decrease the full-scale range, add a $25\text{k}\Omega$ to $250\text{k}\Omega$ external resistor or potentiometer (R_{ADJ}) between REFADJ and GND. To increase the full-scale range, add a $25\text{k}\Omega$ to $250\text{k}\Omega$ resistor between REFADJ and REFIO. Figure 9 shows the two possible configurations.

The following equations provide the relationship between R_{ADJ} and the change in the analog full-scale range:

$$\text{FSR} = 0.7\text{V} \left(1 + \frac{1.25\text{k}\Omega}{R_{ADJ}} \right)$$

for R_{ADJ} connected between REFADJ and REFIO, and:

Octal, 12-Bit, 40MSPS, 1.8V ADC with Serial LVDS Outputs

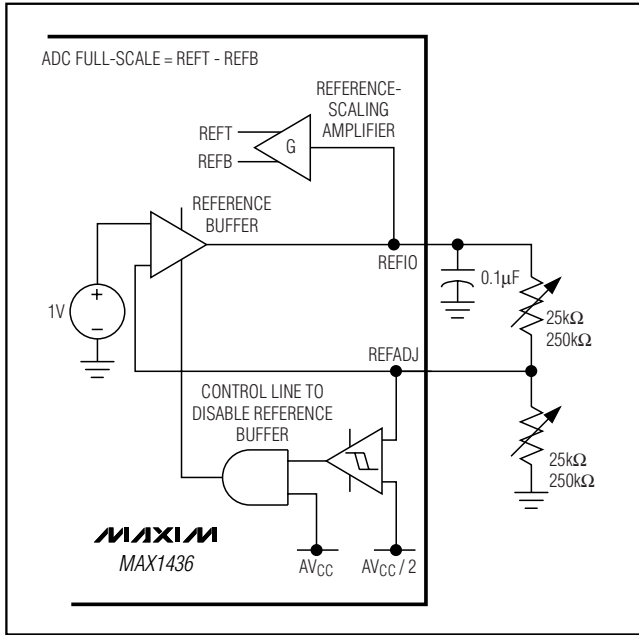

Figure 9. Circuit Suggestions to Adjust the ADC's Full-Scale Range

$$FSR = 0.7V \left(1 - \frac{1.25k\Omega}{R_{ADJ}} \right)$$

for R_{ADJ} connected between REFADJ and GND.

Using Transformer Coupling

An RF transformer (Figure 10) provides an excellent solution to convert a single-ended input source signal to a fully differential signal. The MAX1436 input common-mode voltage is internally biased to 0.76V (typ) with $f_{CLK} = 40\text{MHz}$. Although a 1:1 transformer is shown, a step-up transformer can be selected to reduce the drive requirements. A reduced signal swing from the input driver, such as an op amp, can also improve the overall distortion.

Grounding, Bypassing, and Board Layout

The MAX1436 requires high-speed board layout design techniques. Refer to the MAX1434/MAX1436/MAX1437/MAX1438 EV kit data sheet for a board layout reference. Locate all bypass capacitors as close to the device as possible, preferably on the same side as the ADC, using surface-mount devices for minimum inductance. Bypass AV_{DD} to GND with a $0.1\mu\text{F}$ ceramic capacitor in parallel with a $\geq 2.2\mu\text{F}$ ceramic capacitor. Bypass OV_{DD} to GND with a $0.1\mu\text{F}$ ceramic capacitor in parallel with a $\geq 2.2\mu\text{F}$ ceramic capacitor. Bypass

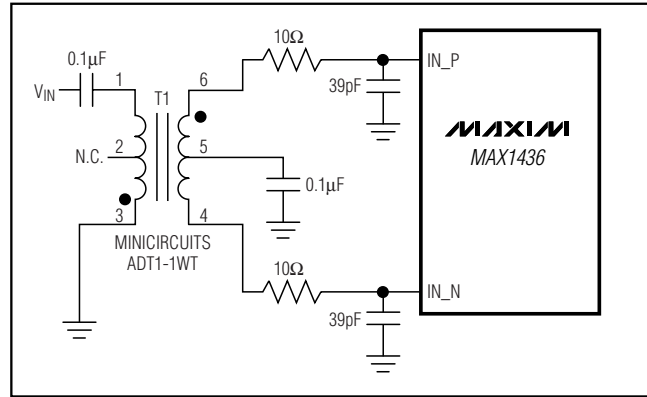

Figure 10. Transformer-Coupled Input Drive

CV_{DD} to GND with a $0.1\mu\text{F}$ ceramic capacitor in parallel with a $\geq 2.2\mu\text{F}$ ceramic capacitor.

Multilayer boards with ample ground and power planes produce the highest level of signal integrity. Connect MAX1436 ground pins and the exposed backside paddle to the same ground plane. The MAX1436 relies on the exposed-backside-paddle connection for a low-inductance ground connection. Isolate the ground plane from any noisy digital system ground planes.

Route high-speed digital signal traces away from the sensitive analog traces. Keep all signal lines short and free of 90° turns.

Ensure that the differential analog input network layout is symmetric and that all parasitics are balanced equally. Refer to the MAX1434/MAX1436/MAX1437/MAX1438 EV kit data sheet for an example of symmetric input layout.

Parameter Definitions

Integral Nonlinearity (INL)

Integral nonlinearity is the deviation of the values on an actual transfer function from a straight line. For the MAX1436, this straight line is between the end points of the transfer function, once offset and gain errors have been nullified. INL deviations are measured at every step and the worst-case deviation is reported in the *Electrical Characteristics* table.

Differential Nonlinearity (DNL)

Differential nonlinearity is the difference between an actual step width and the ideal value of 1 LSB. A DNL error specification of less than 1 LSB guarantees no missing codes and a monotonic transfer function. For the MAX1436, DNL deviations are measured at every step and the worst-case deviation is reported in the *Electrical Characteristics* table.

Octal, 12-Bit, 40Mps, 1.8V ADC with Serial LVDS Outputs

Offset Error

Offset error is a figure of merit that indicates how well the actual transfer function matches the ideal transfer function at a single point. For the MAX1436, the ideal midscale digital output transition occurs when there is -1/2 LSBs across the analog inputs (Figures 6 and 7). Bipolar offset error is the amount of deviation between the measured midscale transition point and the ideal midscale transition point.

Gain Error

Gain error is a figure of merit that indicates how well the slope of the actual transfer function matches the slope of the ideal transfer function. For the MAX1436 the gain error is the difference of the measured full-scale and zero-scale transition points minus the difference of the ideal full-scale and zero-scale transition points.

For the bipolar devices (MAX1436), the full-scale transition point is from 0x7FE to 0x7FF for two's-complement output format (0xFFE to 0xFFF for offset binary) and the zero-scale transition point is from 0x800 to 0x801 for two's complement (0x000 to 0x001 for offset binary).

Crosstalk

Crosstalk indicates how well each analog input is isolated from the others. For the MAX1436, a 5.3MHz, -0.5dBFS analog signal is applied to one channel while a 19.3MHz, -0.5dBFS analog signal is applied to another channel. An FFT is taken on the channel with the 5.3MHz analog signal. From this FFT, the crosstalk is measured as the difference in the 5.3MHz and 19.3MHz amplitudes.

Aperture Delay

Aperture delay (t_{AD}) is the time defined between the rising edge of the sampling clock and the instant when an actual sample is taken. See Figure 11.

Aperture Jitter

Aperture jitter (t_{AJ}) is the sample-to-sample variation in the aperture delay. See Figure 11.

Signal-to-Noise Ratio (SNR)

For a waveform perfectly reconstructed from digital samples, the theoretical maximum SNR is the ratio of the full-scale analog input (RMS value) to the RMS quantization error (residual error). The ideal, theoretical minimum analog-to-digital noise is caused by quantization error only and results directly from the ADC's resolution (N bits):

$$SNR_{dB[max]} = 6.02dB \times N \times 1.76dB$$

In reality, there are other noise sources besides quantization noise: thermal noise, reference noise, clock jitter, etc.

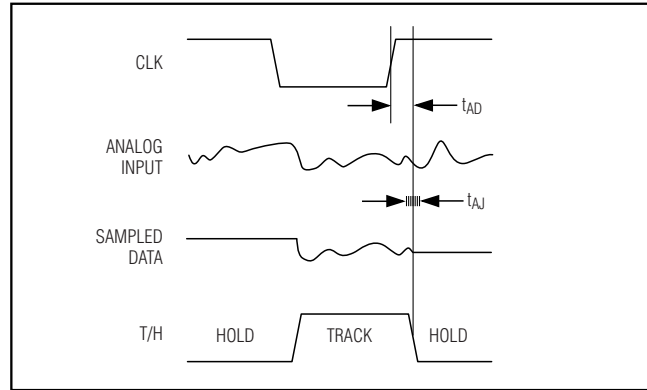

Figure 11. Aperture Jitter/Delay Specifications

For the MAX1436, SNR is computed by taking the ratio of the RMS signal to the RMS noise. RMS noise includes all spectral components to the Nyquist frequency excluding the fundamental, the first six harmonics (HD2–HD7), and the DC offset.

Signal-to-Noise Plus Distortion (SINAD)

SINAD is computed by taking the ratio of the RMS signal to the RMS noise plus distortion. RMS noise plus distortion includes all spectral components to the Nyquist frequency, excluding the fundamental and the DC offset.

Effective Number of Bits (ENOB)

ENOB specifies the dynamic performance of an ADC at a specific input frequency and sampling rate. An ideal ADC's error consists of quantization noise only. ENOB for a full-scale sinusoidal input waveform is computed from:

$$ENOB = \left(\frac{SINAD - 1.76}{6.02} \right)$$

Total Harmonic Distortion (THD)

THD is the ratio of the RMS sum of the first six harmonics of the input signal to the fundamental itself. This is expressed as:

$$THD = 20 \times \log \left(\frac{\sqrt{V_2^2 + V_3^2 + V_4^2 + V_5^2 + V_6^2 + V_7^2}}{V_1} \right)$$

Spurious-Free Dynamic Range (SFDR)

SFDR is the ratio expressed in decibels of the RMS amplitude of the fundamental (maximum signal component) to the RMS value of the next-largest spurious

Octal, 12-Bit, 40Msps, 1.8V ADC with Serial LVDS Outputs

component, excluding DC offset. SFDR is specified in decibels relative to the carrier (dBc).

Intermodulation Distortion (IMD)

IMD is the total power of the IM2 to IM5 intermodulation products to the Nyquist frequency relative to the total input power of the two input tones f_1 and f_2 . The individual input tone levels are at -6.5dBFS. The intermodulation products are as follows:

- 2nd-order intermodulation products (IM2): $f_1 + f_2$, $f_2 - f_1$
- 3rd-order intermodulation products (IM3): $2 \times f_1 - f_2$, $2 \times f_2 - f_1$, $2 \times f_1 + f_2$, $2 \times f_2 + f_1$
- 4th-order intermodulation products (IM4): $3 \times f_1 - f_2$, $3 \times f_2 - f_1$, $3 \times f_1 + f_2$, $3 \times f_2 + f_1$
- 5th-order intermodulation products (IM5): $3 \times f_1 - 2 \times f_2$, $3 \times f_2 - 2 \times f_1$, $3 \times f_1 + 2 \times f_2$, $3 \times f_2 + 2 \times f_1$

Third-Order Intermodulation (IM3)

IM3 is the total power of the 3rd-order intermodulation product to the Nyquist frequency relative to the total input power of the two input tones f_1 and f_2 . The individual input tone levels are at -6.5dBFS. The 3rd-order intermodulation products are $2 \times f_1 - f_2$, $2 \times f_2 - f_1$, $2 \times f_1 + f_2$, $2 \times f_2 + f_1$.

Small-Signal Bandwidth

A small -20.5dBFS analog input signal is applied to an ADC so that the signal's slew rate does not limit the ADC's performance. The input frequency is then swept up to the point where the amplitude of the digitized conversion result has decreased by -3dB.

Full-Power Bandwidth

A large -0.5dBFS analog input signal is applied to an ADC, and the input frequency is swept up to the point where the amplitude of the digitized conversion result has decreased by -3dB. This point is defined as full-power input bandwidth frequency.

Gain Matching

Gain matching is a figure of merit that indicates how well the gain of all eight ADC channels is matched to each other. For the MAX1436, gain matching is measured by applying the same 5.3MHz, -0.5dBFS analog signal to all analog input channels. These analog inputs are sampled at 40Msps and the maximum deviation in amplitude is reported in dB as gain matching in the *Electrical Characteristics* table.

Phase Matching

Phase matching is a figure of merit that indicates how well the phases of all eight ADC channels are matched to each other. For the MAX1436, phase matching is measured by applying the same 5.3MHz, -0.5dBFS analog signal to all analog input channels. These analog inputs are sampled at 40Msps and the maximum deviation in phase is reported in degrees as phase matching in the *Electrical Characteristics* table.

Octal, 12-Bit, 40MSPS, 1.8V ADC with Serial LVDS Outputs

Pin Configuration

MAX1436

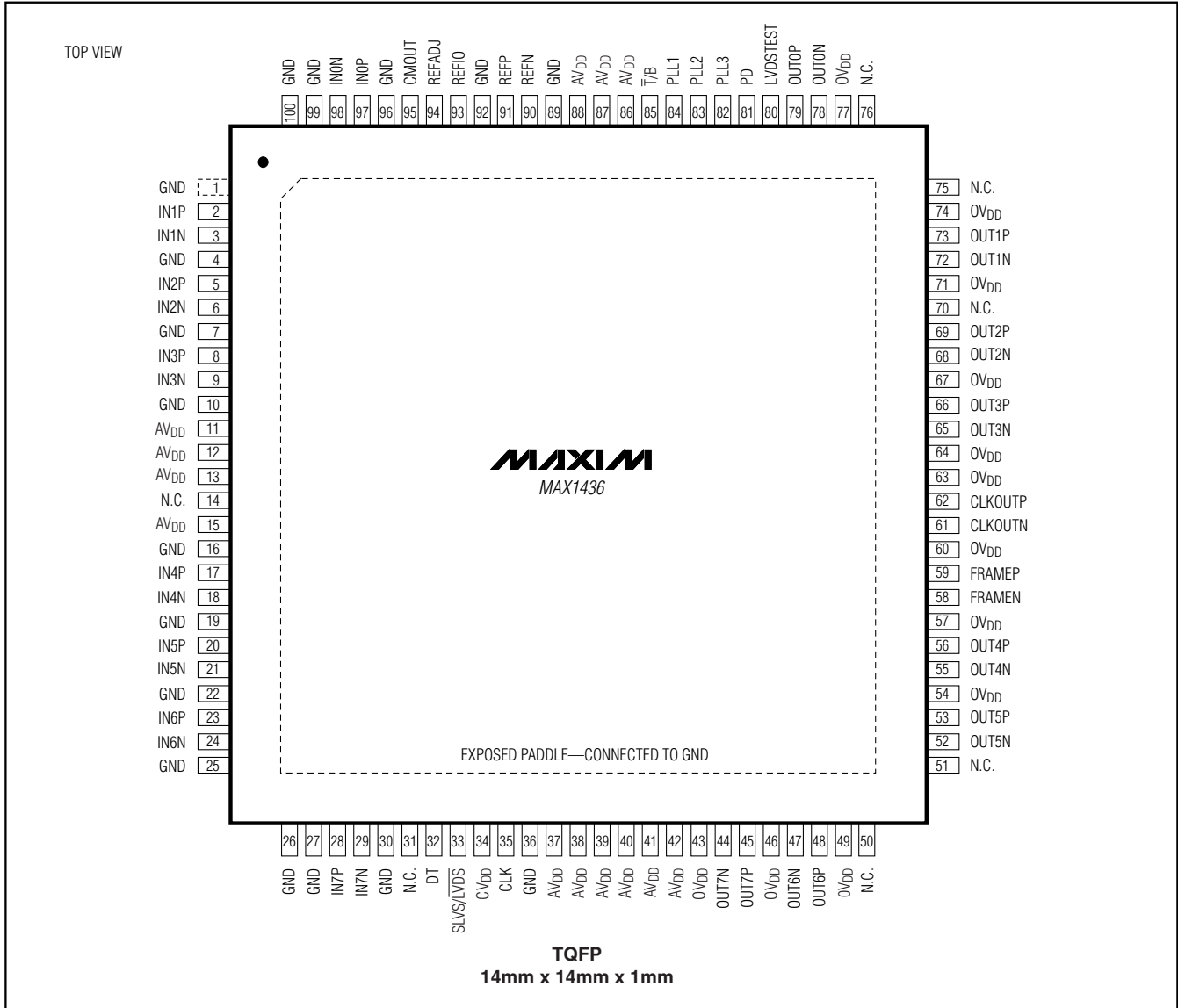

Octal, 12-Bit, 40MSPS, 1.8V ADC with Serial LVDS Outputs

Package Information

(The package drawing(s) in this data sheet may not reflect the most current specifications. For the latest package outline information go to www.maxim-ic.com/packages.)

For the MAX1436 exposed paddle variation, the package code is C100E-2.

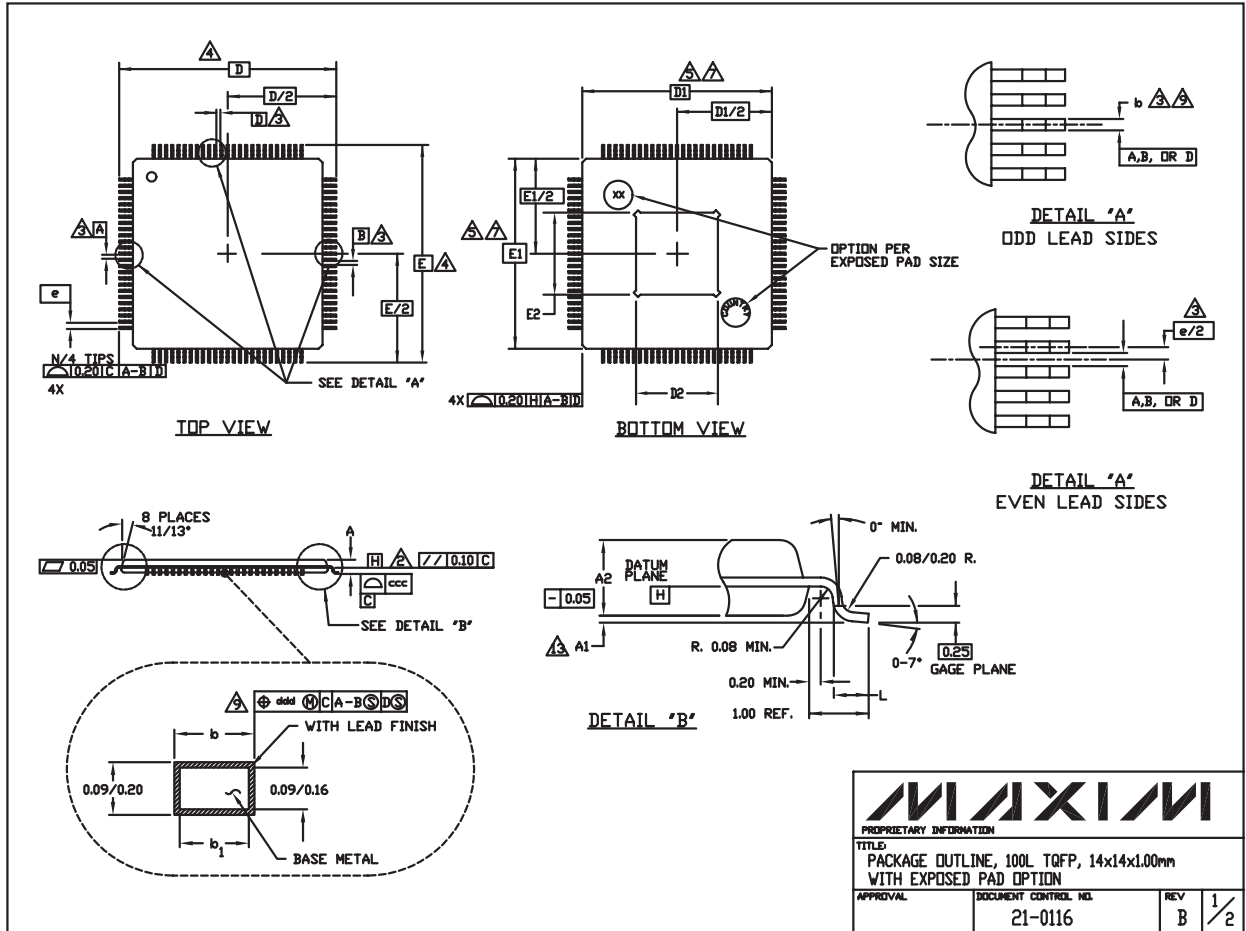

14X14X1.00L TQFP, EXP. PAD:EPS

Octal, 12-Bit, 40Mps, 1.8V ADC with Serial LVDS Outputs

MAX1436

Package Information (continued)

(The package drawing(s) in this data sheet may not reflect the most current specifications. For the latest package outline information go to www.maxim-ic.com/packages.)

For the MAX1436 exposed paddle variation, the package code is C100E-2.

NOTES:

1. ALL DIMENSIONING AND TOLERANCING CONFORM TO ASME Y14.5M-1994.
2. DATUM PLANE [H] LOCATED AT MOLD PARTING LINE AND COINCIDENT WITH LEAD, WHERE LEAD EXITS PLASTIC BODY AT BOTTOM OF PARTING LINE.
3. DATUM [A-B] AND [D] TO BE DETERMINED AT CENTERLINE BETWEEN LEADS WHERE LEADS EXITS PLASTIC BODY AT DATUM PLANE [H].
4. TO BE DETERMINED AT SEATING PLANE [C].
5. DIMENSIONS D1 AND E1 DO NOT INCLUDE MOLD PROTRUSION. ALLOWABLE MOLD PROTRUSION IS 0.254mm ON D1 AND E1 DIMENSIONS.
6. "N" IS THE TOTAL NUMBER OF TERMINALS.
7. THESE DIMENSIONS TO BE DETERMINED AT DATUM PLANE [H].
8. THE TOP OF PACKAGE IS SMALLER THAN THE BOTTOM OF PACKAGE BY 0.15mm.
9. DIMENSIONS b DOES NOT INCLUDE DAMBAR PROTRUSION. ALLOWABLE DAMBAR PROTRUSION SHALL BE 0.08mm TOTAL IN EXCESS OF THE b DIMENSION AT MAXIMUM MATERIAL CONDITION. DAMBAR CANNOT BE LOCATED ON THE LOWER RADIUS OR THE FOOT.
10. CONTROLLING DIMENSION: MILLIMETER
11. MAXIMUM ALLOWABLE DIE THICKNESS TO BE ASSEMBLED IN THIS PACKAGE FAMILY IS 0.50mm.
12. THIS OUTLINE IS NOT YET JEDEC REGISTERED.
13. A1 IS DEFINED AS THE DISTANCE FROM THE SEATING PLANE TO THE LOWEST POINT OF THE PACKAGE BODY.
14. EXPOSED DIE PAD SHALL BE COPLANAR WITH BOTTOM OF PACKAGE WITHIN 0.05mm.

15. METAL AREA OF EXPOSED DIE PAD SHALL BE WITHIN 0.30mm OF THE NOMINAL DIE PAD SIZE.
16. COUNTRY OF ORIGIN MUST BE MARKED ON THE PACKAGE.

| SYMBOL | ALL DIMENSIONS ARE IN MILLIMETERS | | | |
|--------|-----------------------------------|-----------------|------|-------|
| | MIN. | NOM. | MAX. | NOTES |
| A | 0.10 | 0.10 | 1.20 | |
| A1 | 0.05 | 0.10 | 0.15 | 13 |
| A2 | 0.95 | 1.00 | 1.05 | |
| D | 16.00 BSC. | | | 4 |
| D1 | 14.00 BSC. | | | 7,8 |
| E | 16.00 BSC. | | | 4 |
| E1 | 14.00 BSC. | | | 7,8 |
| L | 0.45 | 0.60 | 0.75 | |
| N | 100 | | | |
| e | 0.50 BSC. | | | |
| b | 0.17 | 0.22 | 0.27 | 9 |
| b1 | 0.17 | 0.20 | 0.23 | |
| ccc | 0.10 | 0.10 | 0.08 | |
| ddd | 0.10 | 0.10 | 0.08 | |

| PKG. CODE | D2 | | | E2 | | |
|-----------|------|------|------|------|------|------|
| | MIN. | NOM. | MAX. | MIN. | NOM. | MAX. |
| C100E-2 | 7.7 | 8.0 | 8.3 | 7.7 | 8.0 | 8.3 |
| C100E-3 | 6.2 | 6.5 | 6.8 | 6.2 | 6.5 | 6.8 |
| C100E-6 | 4.7 | 5.0 | 5.3 | 4.7 | 5.0 | 5.3 |

| | | |
|----------------------------------------------------------------------------------------------|------------------------------------------------|----------------------------------------------------------------|
| MAXIM | | |
| <small>PROPRIETARY INFORMATION</small> | | |
| <small>TITLE:</small> PACKAGE OUTLINE, 100L TQFP, 14x14x1.00mm WITH EXPOSED PAD OPTION | | |
| <small>APPROVAL</small> | <small>DOCUMENT CONTROL NO.</small> 21-0116 | <small>REV</small> B 2/2 |

Maxim cannot assume responsibility for use of any circuitry other than circuitry entirely embodied in a Maxim product. No circuit patent licenses are implied. Maxim reserves the right to change the circuitry and specifications without notice at any time.

Maxim Integrated Products, 120 San Gabriel Drive, Sunnyvale, CA 94086 408-737-7600 23